

Design Guidelines For Lowland Spate Irrigation Systems

17



Practical Note Spate Irrigation

1. Introduction

1.1 Characterizing Spate Irrigation Systems

These guidelines concern the lowland spate irrigation systems in Pakistan. They stand out in for the low gradient and general sandy nature of the land, giving the systems a unique character. Water is diverted from the dry rivers usually with soil bunds and then guided over the land with extensive guide bund, the purposing being to slow down and in the words of farmers 'kill' the flood.

Spate irrigation is practiced in all provinces of Pakistan. It differs from surface irrigation system, which operates according to designed parameters with predictable flows whereas in spate irrigation flow varies in occurrence, quantity and time.

Spate irrigation systems in Pakistan are broadly characterized in four categories: (a) non-perennial Spate irrigation systems based on floodwater generated from hill-torrents and diverted through diversion structures (natural, earthen or weir regulated); (b) non-perennial Spate irrigation systems with head-works for diversion of floodwater into a Canal Network and Tanks for storage and regulation of floodwater; (c) perennial Spate irrigation systems based on groundwater which oases out in the form of springs; and (d) integrated Spate irrigation systems having both non-perennial and perennial flows. These guidelines are concerned with non-perennial systems, which are most widespread. The material for these guidelines comes from work under in the last twenty years in Dera Ismail Khan district of Pakistan. This area is typical for other lowland systems in Pakistan. The area consist of four main land form unit i.e. piedmont plain, gravelly, fan/apron, rough broken land and mountains. The main crops grown in the area are wheat, gram and oil seed in Rabi and sorghum and millet in Kharif. About 57% of the land can

be classified as Class I and II i.e. very good and good agricultural land. Water and erosion however are the limiting factors.

Due to un-reliable water availability, non-equitable distribution and weak bund rebuilding mechanism, the system faces considerable problems. Over the time the system has lost almost 50% of its efficiency which lead to negative environmental and economic consequences. Due to lack of public support disputes amongst the communities are frequent. This underlines the need of ensuring sustainability in flood water management.

1.2 Intervention

Over the two decades irrigation structures like spill weirs, sluice gates & earthen water diversion and application structures were constructed in spate irrigated areas of Pakistan (DIKhan). All these structures were developed in head and middle region of the spate command area. The design of structures were developed considering velocity and depth of water in channel, area to be irrigated by virtue of water rights and time of application for required depth of ponding. The structures not only distributed the water equitably but also controlled erosion and reduced the sedimentation so that sustainable and efficient water management systems were ensured.

1.3 Objectives

The objectives of this manual are:

- Development of design manual on spate irrigation based on the (innovative) civil work, earthen bund improvement undertaken in DIKhan, KPK;
- Development of cost effective designs both in investment and O&M using bio-engineering & landscape improvement approaches implemented in Pakistan.

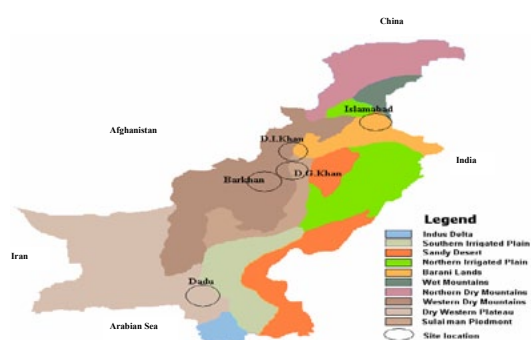

Figure 1: Map showing the location of DIKhan and other Spate irrigated areas of Pakistan.



Figure 2: A low crest weir for water storage

2. Design Process

The design of any scheme is based on the following principles.

- To equitably distribute the flood water as per requirement;
- To make sure the supply of irrigation water to all stakeholders;
- To reduce the community disputes on water issues;
- To improve the socio economic status of community.

2.1 Reconnaissance survey of the area

The reconnaissance survey is the pre requisite to all interventions. It includes a visit to the proposed site of the Spate Diversion Works to have a physical view of the site conditions. During this site visit the concerned beneficiaries have to be met to know their views about the past and present site conditions and any specific requirements. Some of the relevant available information as listed under the following paragraphs may also be collected during this visit.

2.2 Collection of Site Information

Site information includes:

- Site location: Name of watershed & command area, village name, District, Province and nearest city, GPS Coordinates and Index Map;
- Site description: River bed conditions, soil type, channel locations (khullas) and maximum observed water level as may be seen from river bed;
- Command Area: The command area of the various channels (khullas) and their location vis-à-vis the location of diversion works;



Figure 3: Overflow Structure

- Cropping Pattern: Crop types, crop area and yield in the command area;
 - Seasonal flood intensity & occurrence;
 - Spatial & Temporal flow variation and;
 - Desired water application depth in the fields.

2.3 Collection of Hydrological Information

Hydrological information includes data of the catchment area, rainfall, the location of the rain gauges and the flood frequencies of the last 5, 10, 25 and 50 years. This can be obtained either from local communities or from meteorological and irrigation government departments.

3. Design Criteria for Gated Diversion Structures

The gated diversion structures are designed with taken into account flow velocity and water depth in water channels (khullah), the irrigation area by virtue of water rights and time of application. Design criteria for the khullah are bank height, bed slope and surface area. The flow velocity and water depth for a particular discharge can be measured by the Manning's equation below:

$$V = 1/n R^{2/3} S^{1/2} \quad (1)$$

$$R = A/P \quad (2)$$

Where;

- V = mean flow velocity in the khullah, (meter per second)
- R = hydraulic radius, (meter)
- S = slope (%)
- n = roughness co-efficient, (taken as 0.04 for uncovered earthen channel).



Figure 4: Gated Diversion Structures (1)

Whereas,

- A = area of the khullah (meter)
- P = wetted perimeter (meter)

When data of the irrigation area (a in m²), depth of water applied (d in meter) and time of irrigation (t in sec, during previous seasons) is collected, the anticipated water discharge can be calculated by the following equation;

$$Qt = a * d \quad (3)$$

The surface area of the diversion structure can be estimated by equation 4;

$$A = Q/V \quad (4)$$

Where;

- Q = discharge required to irrigate the field (calculated from Eq. 3);
- A = surface area of the diversion structure, (m²);
- V = flow velocity in khullah (calculated from Eq. 1).

In the calculations, the gates are considered as rectangular and the flow depth (d) is taken proportional to the height of field bank. Finally considering the elevations of the field, the width (b) is adjusted according to the area of structure using the following equation;

$$A = b*d \text{ and } b=A/d \quad (5)$$

After finding the exact width of a gate, the numbers of gates are calculated. A diversion structure may have max. 3-4 gates to avoid over-complex operation (figure 3). The discharge varies from 5 to 6 m³ s⁻¹ for 3 to 4 gated structure whereas it was 1.68 m³ s⁻¹ for single gated structure (Table 1). Figure 5 and 6 shows a front and side view illustration of a three gated diversion structure design.

Furthermore a stability analysis can be carried out by estimating the forces acting upon the diversion structure during operation.

Structure Type	Full Discharge Capacity (m ³ s ⁻¹)	Height (m)	Width (m)
One gate	1.68	1.70	1.30
Three gates	5.04	3.04	4.86
Four gates	6.72	3.04	6.30

Table: 1 Design parameters of the gated diversion structure

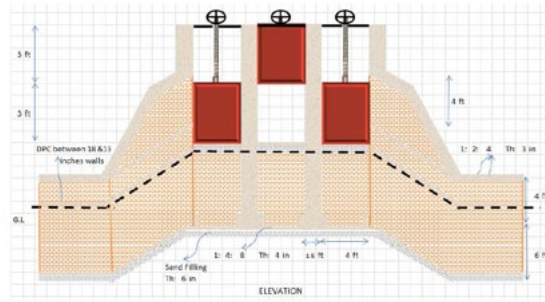

Fig 5: Front View of a three gated diversion structure

These forces mainly include water pressure and pressure of sediment load

The following equation is used to calculate the active pressures on the structure:

$$P = r * h \quad (6)$$

Where;

- P= pressure in Psi,
- r= specific weight of water in lbs/in² and
- h= head of water in inches

The type of reinforcement and the weight of structure is taken into account in the calculations. Bricks, stones, cement, sand gravel and steel are used for construction. Upstream and downstream, aprons are developed to dissipate the energy of flowing water. The banks are reinforced with stones and earthwork provided by tractor and manual labor.

In order to ensure equal water distribution, local knowledge from the farmers is incorporated in the technical design. The community will share in labor and water transportation cost that is normally 15-20% of the total cost.

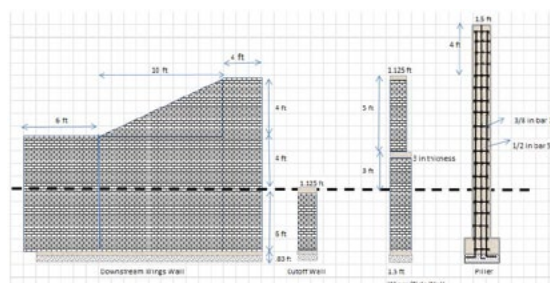

Fig 6: Side view of the three gated diversion structure



Figure 7: Gated Diversion Structures (2)

4. Design Criteria for Spate Spillways (Stone masonry & RCC)

The RCC spillways were the first type of spillways constructed in spate irrigated areas of DIKhan, KPK with the main purpose to:

- To drain excess water out of the system to a safe disposal channel;
- To reduce pressure on the main earthen bund by releasing water above the spillway crest.

The equation for the flow over the spillway is taken as:

$$Q_w = K C B h^{3/2}$$

where:

- Q_w = the discharge over the side spillweir;
- K = the coefficient for oblique flow over the weir;
- C = taken as 1.7 for a broad crested weir;
- B = the crest length of the spillweir;
- h = the design head over the crest where $h = (y_0 - y_1)$;
- y_0 = the upstream head at the head of the diversion embankment.



Figure 9: Stone Gabion Spillway, KPK (1)

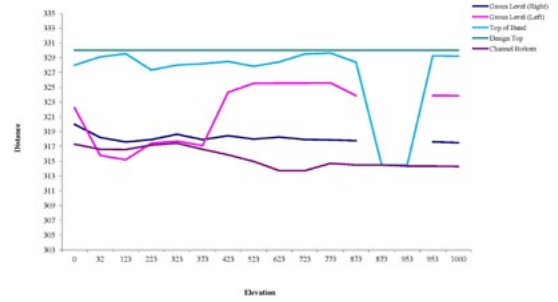

Figure 8: Profile of the Channel at Pal Kot Musa & spillway site

The crest level b is determined from level $d + y_1$ where d is the wadi bed level at the entrance to the canal.

To determine the depth y_0 Manning's equation can be applied to the wadi flow taking the full width of the wadi W , similar to step 2). This depth is calculated for the design flood in the wadi. For a flood less than this, a backwater curve would occur. The distribution of flow between the wadi channel and that passing into the canal entrance and over the spillweir for different return periods is assessed by trial and improvement, but in general with the offtake closed the flow distribution is about 5% over the spillweir and 95% in the wadi. This ratio changes if the offtake gates are opened or if a sluice is provided as shown in Figure 9.

The modular ratio at the spillweir needs to be checked such that:

$$(hd / h) < 0.7$$

where hd is the downstream head over the weir. If $(hd / h) > 0.7$ then the coefficient of discharge C would need to be reduced, however it is expected that this situation should not occur.



Figure 10: RCC spillway (Upstream) Kot Musa, DI Khan

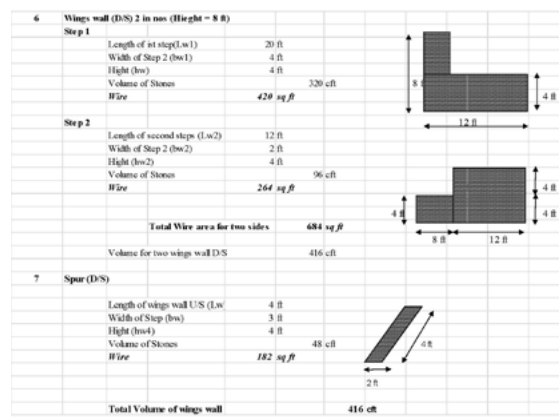
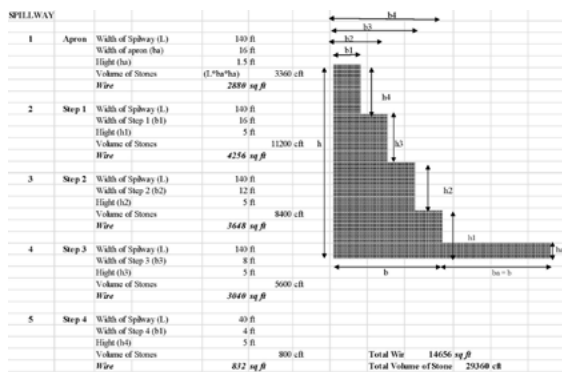

Figure 11: Dimensions of the spillway, wingwalls and spur

If the flow into the canal under flood conditions is likely to endanger the canal integrity then a further spillway should be provided in the canal headreach to reject excess water back to the wadi. A gabion mattress protected embankment may be sufficient.

In Pal Kot-musa more detailed calculated steps have been followed in the designing process. For an overview see annex 1.

5. Design Criteria for Retaining Walls

In some cases a retaining wall is required to safeguard the village population against possible flood hazard. A concrete wall serves the purpose to deflect the water away from populated area and also withstands the water pressure against the earthen bund, which is subject to damage otherwise. In other words it serves the purpose of Disaster Risk Reduction (DRR) structure.

Retaining walls are to be designed using the following parameters:

- Moist density of coarse sand compacted backfill
- Saturated density of coarse sand compacted backfill
- Density of water
- Effective angle of internal friction
- Active earth pressure coefficient K A
- Passive earth pressure coefficient K P
- The surcharge on the top of the wall is taken as
- The density of masonry
- The density of concrete
- The friction angle masonry/concrete
- The friction angle concrete/soil
- Maximum allowable compressive strength in masonry
- Maximum allowable tensile strength in masonry
- Maximum allowable compressive strength in concrete



Figure 12: Stone Gabion Spillway, KPK (2)

- Maximum allowable tensile strength in concrete
- Maximum soil bearing pressure

A sample calculated R/W design is given below to understand the steps taken in the process.

5.1 Earth pressure (P)

Earth pressure is the pressure exerted by the retaining material on the retaining wall. This pressure tends to deflect the wall outward. There are two types of earth pressure and they are; Active earth pressure or earth pressure (Pa) and Passive earth pressure (Pp). Active earth pressure tends to deflect the wall away from the backfill. Earth pressure depends on type of backfill, the height of wall and the soil conditions.

The different soil conditions are:

- Dry leveled back fill
- Moist leveled backfill
- Submerged leveled backfill
- Leveled backfill with uniform surcharge
- Backfill with sloping surface

The active pressure on a retaining wall due to granular backfill is given by Rankine's formula:

$$P = \frac{1}{2} \times w \times H^2 \times \frac{(1 - \sin f)}{(1 + \sin f)} \times k_a$$

where:

- P = Active pressure (lb/ft²)
- w = Density of the backfill (lb/ft³)
- H = The height of the backfill (in feet)
- f = Angle (in degrees^o)

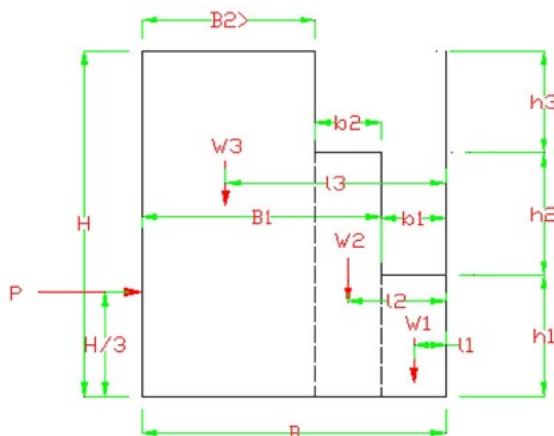

Fig 13: Dimensions of a Retaining wall

5.2 Stability requirements of RW

Following conditions must be satisfied for stability of wall.

- It should not overturn;
- It should not slide;
- It should not subside i.e Max. pressure at the toe should not exceed the safe bearing capacity of the soil under working condition.

Check against overturning

The overturning moment caused by the earth thrust may exceed the stability moment of the weight of the wall Formula against overturning:

$$OTM = P \times H/3$$

where:

- OTM = Overturning moment
- P = Active pressure (lb/ft²)
- H = The height of the backfill (in feet)

Check against sliding

Resistance to sliding is checked by comparing the horizontal thrust from the backfill with the resisting friction and adhesion forces at the base of the wall.

The formula against sliding is:

FOS = Resisting force to sliding/Horizontal force causing sliding

$$= \mu \sum W/P \times 1.5$$

where:

- FOS = Factor of safety
- μ coefficient of friction = $\tan \delta$
- $\sum W$ = Total vertical force acting at the key base
- $\mu \sum W$ = Total frictional force under flat base
- P = Active pressure (lb/ft²)



Figure 14: Retaining wall under construction



Figure 15: Earthen embankments under construction



Figure 16: Earthen Embankment used for transport

Check against subsiding

For stability earth pressure at the end of the heel for the entire height of wall should be considered.

In annex 2 an example of design calculations for an earthen bund is given. Furthermore it includes a calculation of the total working hours and costs for tractors to move a particular volume of soil.

6. Design Criteria for Earthen Bunds / Embankments

Earthen bunds are a vital part of the spate irrigation system. They are constructed and managed by the farmers. These structures are designed to store as efficient as possible the water that is needed. The main challenge is that sediment transport, scouring and siltation are in hydrological equilibrium. Earthen bunds are also used in the secondary and tertiary channels. In secondary channels earthen bunds are used for diversion and flood control within the channel network. In tertiary channels, they are used for diversion of water from the channel to the field. For designing an earthen bund / embankment, the parameters which need to be considered are shown in the figure below.

Where;

- H = Height
- b = Top Width
- B = Bottom Width
- Side slope = Z: 1
- Length = L
- Volume of earth = $((b + B) / 2) * H * L$

7. Design Criteria for Flood Channels & Field Inlets

7.1 Flood Channels

The spate irrigation system has primary (carrying most of the flood), secondary (having diverted flow which is less than primary) and tertiary (carrying water to the field) channels. The size of the channels is based on the demand to carry a certain amount of discharge.

If the discharge is known the Manning Equation can be used to estimate other parameters:

$$Q = 1.49 * (R)^{0.667} * (S)^{0.5} / n$$

Where:

- R = A/P
- A = Area
- S = Slope
- P = Wetted Perimeter
- n = Manning's roughness coefficient
- Q = Discharge

The bed slope is often higher in the head of the command area and gradually decreases in middle to almost nil in tail region. However to keep a non-erosive flow velocity in the channel a bed slope of 1 in 1.000 is recommended.

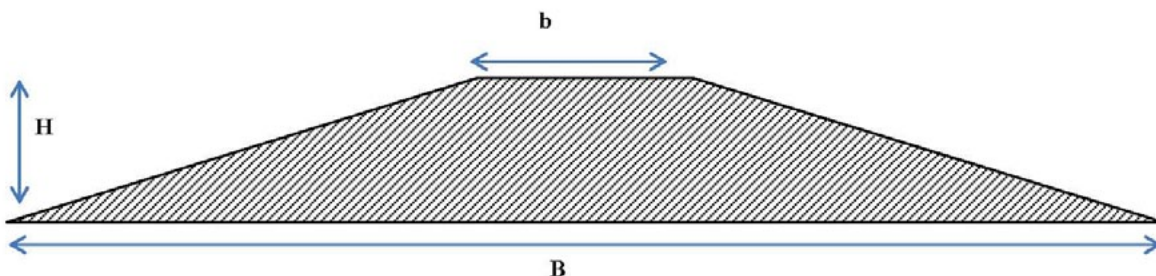

Fig 17: Dimensions of an earthen bund

De-siltation	
Length of the channel section	600 ft
Width	60 ft
Depth	3.55 ft
Volume of desiltation = L*W*D	127,800 cft
Tractor Hours @ 400 cft /hour	319,5 hrs

Table 2: Calculation example for calculating the volume of de-siltation

Periodic de-siltation of the channels are carried out to keep the flood water flowing without any obstruction. See table 2 for the method used for calculating the volume of de-siltation and developing the section of the channel as per requirement.

7.2 Field Inlets

These are the micro-structures constructed at end of the spate irrigation network and are used to irrigate one or two fields. Since flood water is allowed to enter the field and deep pool is developed to harness water for crop cultivation, therefore the size of field inlet is very important to fill up the field basin to a desired depth in allocated time. The formula used for calculating the size of the inlet to pass certain flow (discharge) is given as:

$$Q_t = a * d$$

Where;

- Q= discharge
- T=time of filling the field to a certain depth
- A= area of the field
- D= depth of water ponding

The field inlets are either single or double with respect to their water passing capacity. The height of the structure is kept a foot above the bund height to keep room for the soil deposit in coming years.

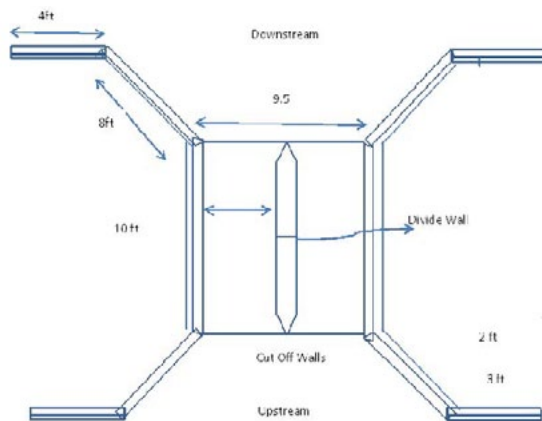

Figure 19: Conceptual diagram of a two way field inlet structure



Figure 18: Field Inlet structure (under construction)

Wooden planks are used to open or close the field inlet after the irrigation is completed.

Figure 19 presents a typical drawing section of a two way inlet structure being constructed in thousands in spate irrigated areas of Pakistan. The masonry inlet reduces the labour involved in closing the earthen inlet in flowing water. Bricks and stone masonry are often used for construction depending upon the ease of availability of material. For detailed design calculations field inlet structure see annex 3.

7.3 Low crest weir for bed stabilization

These types of structure are not common in the spate irrigation systems of KPK. However there are several of these structures in Baluchistan. Low crest weirs are constructed across the channel or river bed, where erosion and destabilization of banks is an issue. It elevates the water level and reduces the flow velocity, causing sediment deposit upstream and stabilizes the bed of the channel.

A typical section of the bed stabilizing weir is given in the figure below. In case of low flows and reduced velocities in the plain areas, sheet piles and inverted filters can be used to compromise in water flow.

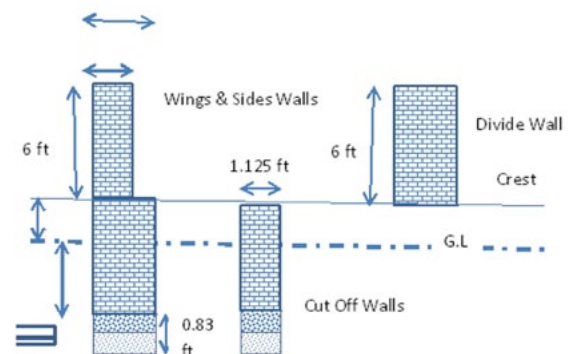

Figure 20: Foundation of the field inlet structure

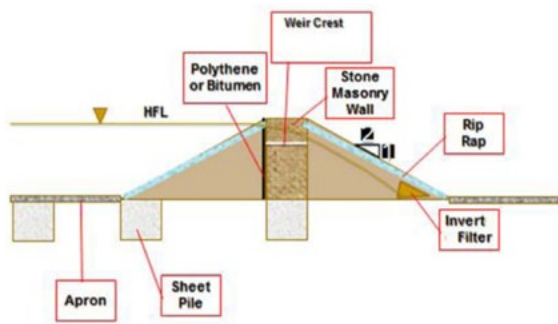

Figure 21: Conceptual diagram of a Weir Crest



Figure 22: A bed stabilization weir

8. Community Based O&M Procedures

Community based O&M committees have been formed in order to take care of the operation and maintenance of spate irrigation infrastructure. Extensive trainings are organized for all O&M committees' members to build their capacity in proper maintenance.

In some of the areas, sub committees in O&M, procurement, monitoring and evaluation are formed. This in consultation with community and water user groups (WUGs).

Monitoring & Supervision Committee

The Village Organization (VO) forms an M & S Committee comprising at least two members. This committee is responsible for the overall implementation of the project scheme. They are responsible to keep the record of funds received, expenditures made on purchase of material and payments made to the labor etc.

The committee is also responsible to inform the donor on the physical progress of the project before receiving funding.

Audit Committee

The beneficiary VO forms an Audit Committee comprising at least two literate members representing the beneficiary VO. This committee is responsible to prepare a audit report before requesting funding from the donor. The committee will check the financial records and accounts of the project maintained by the M & S Committee.

Operation and Maintenance Committee

The VO set up an O & M Committee for the maintenance of the project. The committee is responsible to supervise the repair & maintenance operations of the project once it is completed. They will also ensure that all the beneficiaries are equally involved in the maintenance process. Maintenance Committee will also undertake the responsibility to generate the funds required for the repair & maintenance of the project. A separate bank account will be maintained for this purpose. The committee is also responsible for resolution of any dispute.



Figure 23 -24: Community Meetings

Annex 1: Design Calculations RCC Spillway at Palkot Musa, KPK, Pakistan

Survey Sheet for Design of RCC spillway structure at Pal Kot Musa, KPK

Distance	Ground Level (Right)	Ground Level (Left)	Top of Bund	Design Top	Difference	Channel Bottom	
0	319.979525	322.210605	327.985165	330	2.014835	317.289105	Bund start
32	318.207785	315.779845	329.100705	330	0.899295	316.600095	
123	317.584395	315.189265	329.527235	330	0.472765	316.567285	
223	317.912495	317.420345	327.328965	330	2.671035	317.157865	
323	318.634315	317.715635	327.985165	330	2.014835	317.420345	
373	317.912495	317.092245	328.182025	330	1.817975	316.600095	
423	318.437455	324.310445	328.477315	330	1.522685	315.845465	Bund End
523	317.978115	325.524415	327.821115	330	2.178885	314.959595	
623	318.257	325.557225	328.411695	330	1.588305	313.712815	
723	317.9289	325.557225	329.494425	330	0.505575	313.712815	
773	317.86328	325.590035	329.625665	330	0.374335	314.697115	
873	317.76485	323.86751	328.36248	330	1.63752	314.48385	Start of cut
873			314.48	330		314.48	
953			314.48	330		314.3198	End of cut
953	317.6008	323.86751	329.24835	330	0.75165	314.3198	
1000	317.5	323.85	329.2	330	0.8	314.28	
					19.249695		

Design parameters for the construction of an RCC spillway in spate areas

1	Inlet Design										
	Required		Q =	500	cfs						
		Assumed b =	b1 =	30	ft				Check		OK
		Assumed d1 =		2.925	ft	Designed d =		2.925	Q =		3.33b1(d1) ^{3/2} =500
			S1 =	0.0003							
			z =	0							
			n =	0.01							
2	Elevation of the energy gradient line from bed level:										
		A1 =		87.75	ft ²						
		V1 =		5.7	ft/sec						
		hv1 =		0.5	ft						
		E1 =	d1+hv1	3.425	ft	The elevation E1 = Invert Elevation+E1					
3	Inlet Transition :										
	Assuming that critical velocity occur at section 2 (at the start of Chute)										8.5
											0.1494
											15
		Assuming Chute width (b2) =		20	ft	(Assume 1/2 of the channel width)			2.2417		
		q = (Q/b2) =		25	(cft/ft)			2			
		Critical depth $d_c = (q^2/g)^{1/3}$			2.69	ft			4.4835		
		Critical area $A_c =$		53.8	ft ²	Considering rectangular cross-section)					
		Critical Velocity $V_c = (Q/A_c) =$			9.29	fps					
		$h_{vc} = (V_c^2/2g) =$			1.34	ft					
		Rc =		2.12	ft						
		For n=		0.01							
		Sc =		0.0014							
		Ec =		4.03							

4		Losses in the inlet transition:										
			Assuming	Inlet convergence Loss = $0.20\Delta h_v$ where $\Delta h_v = h_{vc} - h_{v1}$								
				Friction Loss = length of transition $\times (s + s_c) / 2$								
		Assuming Length of Transition =	15	ft								
		Convergence Loss =	0.17	ft								
		Friction Loss =	0.01	ft								
5		Energy Balance equation:								=	0.14835	
		E1-Ec-Transition losses=Elevation of point 2	-0.785	it means point 2 is lower than point 1 by				0.79 ft	Tan $\theta =$	0.36397		
								L =	10			
6		Maximum angle of deflection of Inlet side walls:		Cotangent $\alpha = 3.375F$				P =	5.45			
		F = Froud Number =	$V / \sqrt{(1-K)g d \cos \theta}^{1/2}$				2P =	10.92				
		K = 0 with the floor of the plane transition				Available with of chute =				19.08		
		Cos $\theta =$	1									
		F1 =	0.59		Considering rectangular section at point 1 (A=bXd)=				87.75			
		F2 =	1		and V = Q/A =		5.7					
		Mean Value of F =	0.795									
		Cotangent $\alpha =$	2.683125		0.3727							
		$\alpha = \tan^{-1}(1/Cot\alpha) =$	0.3567525									
		$\alpha =$	20.44041		=		20 °					
		This is max angle of deflection, by experiments it is proved that an angle of				20	° is for				15ft	

7	Determination of flow in the Chute Section:					Transition
	Length of Chute section =	25	ft			
	Slope of the Chute Section = S3	0.33				
	Using the Bernauli's Eqn to balance the energy at various points in the Chute Section we can find depth of water in Chute section by trial and error					
	At section 2 we know that:					
	d2=	2.69				
	Hv2=	1.34				
	Z =	SX L				
	where s = slope in chute section and L is the length of the Chute section:					
	Z =	8.25	ft			
	Energy at point 2	E2=	12.28	ft		
	For Energy at point 3 Assuming d3 =			1.181	ft	
					Un-till E2 = E3	
	A3 =	23.62	ft ²			
	V3 =	21.17	fps			
	hv3 =	6.96	ft			
	Avg Slope in Chute section = (S2+S3)/2 =				0.1657	
	hf3 =	Sa X L3 =		4.14	ft	
	E3 =	12.28	ft			
	So d3 =	1.18	ft	OK		
	A minimum of	26.16	inches			

8	Design the Trajectory and stilling pool:							
a	If slope is continuous:							
	At the inlet of the trajectory depth $d_3 =$					1.18	ft	
	and Velocity is $V_3 =$					21.17	fps	
	Froud No is $F_3 = V_3/\sqrt{gd_3} =$					3		
	For depth at the end of trajectory $d_4 = d_3/2(\sqrt{1+8F_3^2}-1) =$					4.45096	Ft	
	From graph 124-1							
	For $F_3 =$	3	L/d_4 for a slope of	0.33	is	6.08		
	So Length of jump becomes $=L =$					27.0619	ft	Say 28 ft
	Now d_4'/d_4 for a slope of					0.33	is	3.4
			so $d_4' =$		15.13	ft		
b	If Slope is non continuous:							
	At the inlet of the trajectory depth $d_3 =$					1.18	ft	
	and Velocity is $V_3 =$					21.17	fps	
	Froud No is $F_3 = V_3/\sqrt{gd_3} =$					3		
	For depth at the end of trajectory $d_4 = d_3/2(\sqrt{1+8F_3^2}-1) =$					4.45096	Ft	
	For slope	0.33	and for $T_w/d_4 =$	1.1	L_t/d_4 becomes =	1 ft		
	so Length of toe $=t =$					4.4509622	say	5 Ft
c	Length of the Pool:							
	Condition for continuity of slope in Chute section (Yes or No):					No		
	length of the pool is normally 4 times d_4							
			Length of the Pool= $=$		13.3529	say	14 ft	
	Height of walls including free board =					2	ft =	6.45096 Say 7 ft
d	Length of the Riprap:							
			$L_r = 5d_4 =$		22	ft		

Annex 2: Design Calculations for Earthen Bunds, Pakistan

Design / Estimate of Earthen Work (Sample)

A. Cut Section		BUND				SOIL			
S. No	L	Ave H1	Top (b)	Bottom (B)	Net Volume				
1	260	5.82	10	44.94	41585.00				
2	350	9.26	10	65.56	122436.55				
3	40	7.28	10	53.70	9277.89				
4	300	7.32	10	53.89	70113.65				
Volume of soil fill the cut portion					243413.09	cft			
B Tractor Hours @400 cft/hr				608.53	hours				
Breast Wall (Plastic Bags fill of Soil)									
		length	Width	Height					
Volume of Wall		110	3	2	660	cft			
Volume of a Bag		2.5	1.5	0.5	1.875	cft			
No's of Bags					352	Nos			
L	H before imp	H after Imp	BUND		B1	B2	SOIL		
			b1 before imp	b2 after imp			Volume1	Volume 2	Net Volume
400	3.56		10	10				0	0
124	7.48		10	10				0	0
180	7.43		10	10				0	0
540	6.80	7.47	5	10	45.82	49.85	93342.61	112648.43	19305.83
800	7.33	8.41	5	10	48.95	55.48	158092.41	198406.80	40314.39
150	10.07	14.57	6	10	66.43	93.39	54711.94	83494.09	28782.15
								Volume of soil for improvement	88402.36
								Tractors hour	221.01

Colofon

This note was prepared by Noman Latif (Short Term Consultant).

The Practical Notes series is prepared as part of the strengthening the Spate Irrigation Network, supported by IFAD, UNESCO-IHE DUPC, World Bank and Royal Netherlands Embassy Islamabad, Pakistan.

The Spate Irrigation Network supports and promotes appropriate programmes and policies in spate irrigation, exchanges information on the improvement of livelihoods through a range of interventions, assists in educational development and supports in the implementation and start-up of projects in Spate irrigation. For more information: www.spate-irrigation.org.



Kingdom of the Netherlands

