

Sana'a University  
Water and Environment Center (WEC)



# **Evaluating the potential of road rain water harvesting in Yemen**

## **A case study of the Maghrabah Manakah Bab Bahil Road, Sana'a Governorate**

**A thesis submitted to Water and Environment Center – Sana'a University  
in partial fulfilment of the requirements for the Master degree in  
Integrated Water Resources Management**

**By**

**Mohammed A. Al-Abyadh**  
B.Sc in Civil Engineering

Under the supervision of

**Main Supervisor**

**Dr. Sharaf Adeen Abdullah A. Saleh**  
Associate Prof. of Water Resource  
and Irrigation

**Co-Supervisor**

**Dr. Abdullah Ahmed Al-Maswari**  
Assistance Prof. of Highway

**Water and Environment Center (WEC)**  
**2018**

## **Abstract:**

Farmers and people living in Manakah area are suffering from water scarcity and limited water resources. The objective of this research is to optimize the benefits of water harvesting from roads for the local communities in socio-economic development (water storage volume and the beneficial reuse of it). This is focusing on the road of Maghrabah Manakah Bab Bahil Road (non-asphaltic road under construction, with length of about 36 km) and the linked rural feeder road Jabal Ekbari and Jabal Awi Road (rural feeder road stone paved in critical sections with total length of around 16 km) Sana'a Governorate. Also, it discussed the role of geometric design of the road to enhance the water harvesting from the road.

The research approach concentrated on a reconnaissance survey for farmers' initiatives with random explanatory farmers' sample interviews, and semi-structured questionnaire. Moreover, a questionnaire was filled by the specialist's road engineers. Also a road geometry review was conducted. Finally, a calculation of the potential rainwater harvesting for main road and sub-road were conducted with water harvesting balance.

The research found out that the farmers benefits of Road Rain Water Harvesting (RRWH) are increasing of the water availability for groundwater recharge, supplementary irrigation and cover needs in dry season. The research come up with the fact that road construction from farmers point of view may affect farm flooding which cause farm gullies and delivery debris and sediments as well as change of farm level.

On the other hands, road engineers' awareness on the concept of water harvesting and water for irrigation from road surface and road structures was not considered by most of the road engineers unless they were requested by farmers.

The research concluded that the main road catchment yield is affected by the natural road catchment, the culverts catchments, and the road surface geometric properties. Moreover, the estimated potential RRWH quantity from the whole main road through natural catchment is (1,662,729.25 m<sup>3</sup>).

Finally, the research recommends the encouraging and improving farmer's initiatives technically and institutionally. And awareness and training workshops should be arranged for road engineers with hydrologic and watershed specialist. Moreover, the road geometric design should be adopted with contoured drawing to facilitate road rainwater harvesting.

**Key words:** Roads Rainwater Harvesting, Road Engineers, Farmers.

## **Acknowledgements**

Praise to ALLAH the exalted and almighty for giving me the opportunity, knowledge and strength to complete my thesis research.

First of all, I would like to thank my main supervisors Dr. Sharafeddin A. A. Saleh, Associate Professor in Water Resource and Irrigation, Water and Environment Center, Sana'a University, for his continuous positive feedback, guidance and valuable efforts during his supervision of this thesis research. I would like to thank my co-supervisors Dr. Abdullah Ahmed Al-Maswari, Assistance Professor of Highway, Civil Engineering Department, Faculty of Engineering, Sana'a University, for his comments, efforts and valuable assistance during his supervision of this thesis research. I further appreciate the encouragement and support from Prof. Dr. Abdullah Babqi (God's mercy permeates his soul), Dr. Adel Al-Weshali, Dr. Bilkis Zabara, Dr. Fadhl Al-Nozaily and all WEC lecturers, staff and colleagues.

I am grateful for the support provided by Nuffic NICHE27 Grant (No.CF 7473) for the project entitled "Strengthening research capacity in Yemen's water sector" under the observation of MetaMeta Research represented by Prof. Frank Van Steenburg, the contact org. and contract holder for implementing the researches grant with WEC support. Thanks are extended to the feedback from first presentation workshop of my fieldwork results which held in WEC.

I would also like to thank the road engineers for their kind help in filling the questionnaire.

My fieldwork would not have been possible without the kind hospitality of local people and farmers in the study area of Manakha, I am very much grateful to them for their nice accompany and I am particularly obliged to the farmers whom I interview them for their information and time.

I greatly appreciate the assistance of Eng. Badran Ali in providing help in GIS maps. I was pleased to thank Dr. Ali Al-Ghail who kindly provided me with a hard copy of Nama'a NGO activities in the study area.

Furthermore, I would like to warmly thank all my friends who support and encourage me.

Finally, my best thanks to all people who have helped me in making the successful achievement of this thesis.



## قرار لجنة المناقشة والحكم رقم (١٧٨) لسنة ٢٠١٨ م

انه في يوم الاحد ٢٥/١٠/١٤٣٩ هـ الموافق ٢٠١٨/٧/٨ م ، أجتعت لجنة المناقشة والحكم على رسالة الماجستير المقدمة من الطالب / محمد عبدالله احمد الابيض المسجل بكلية مبركز المياه والبيئة قسم الادارة المتكاملة للموارد المائية والمشكلة بقرار مجلس الدراسات العليا والبحث العلمي في محضر إجتماعه (٢) بتاريخ ٢٠١٨/٣/٢٤ بتشكيل لجنة المناقشة والحكم من الأساتذة :-

١. د. فضل علي النزلي	الممتحن الداخلي	جامعة صنعاء	رئيسا
٢. د. شرف الدين عبدالله احمد صالح	المشرف الرئيسي	جامعة صنعاء	عضوا
٣. د. فؤاد محمد يحيى الجرزموزي	الممتحن الخارجي	جامعة ذمار	عضوا

عن رسالته الموسومة بـ (تقييم إمكانية حصاد مياة الامطار من الطرق في اليمن- دراسة حالة لمشروع طريق مغربية مناخية- باب باحل- محافظة صنعاء)

قام الطالب بعرض موضوع رسالته على لجنة المناقشة والحكم وتمت مناقشة الطالب . وبناءً على ماتقدم فإن اللجنة توصي بالاتي :-

يُمنح الطالب / محمد عبدالله احمد الابيض درجة الماجستير في المياه والبيئة تخصص : ... لإدارة ... الماء ... للموارد المائية

\* بتقدير : (ممتاز) جيد جدا جيد وبمعدل 90% (يرجى مراعاة وضع دائرة حول التقدير المناسب للطالب)

توقيعات أعضاء لجنة المناقشة والحكم على القرار :-

الإسم	الصفة	التوقيع
د. فضل علي النزلي	الممتحن الداخلي	
د. شرف الدين عبدالله احمد صالح	المشرف الرئيسي	
د. فؤاد محمد يحيى الجرزموزي	الممتحن الخارجي	
مدير عام الدراسات العليا		

نائب رئيس الجامعة للدراسات العليا  
والبحوث العلمي

\* يعتبر التقدير المشار إليه عاليه ، جزء من التقدير العام ؛ بينما يخضع التقدير العام لأكثر من معيار بناءً على لائحة التعليم العالي.

# **TABLE OF CONTENTS**

	<b><u>Page</u></b>
Abstract	
Acknowledgements	
List of Figures	iv
List of Tables	vii
Glossary	viii
Acronyms and Abbreviations	ix

## **CHAPTER ONE: INTRODUCTION**

1.1 Background	1
1.2 Problem statement (Research needs)	2
1.3 Research Objectives	4
1.4 Framework of the research	6
1.5 Research Organization	7

## **CHAPTER TWO: LITERATURE REVIEW**

2.1 Rainwater Harvesting (General Background)	9
2.2 Roads and Water	11
2.2.1 Road catchment	11
2.2.1.1 Catchment Types	12
2.2.1.2 Catchment width	12
2.2.1.3 Catchment length	12
2.2.2. Roads geometric design	15
2.2.3. Roads drainage	21
2.3. Roads rainwater harvesting	23
2.4 Benefits and advantages of road water harvesting	29

## **CHAPTER THREE: STUDY APPROACH**

3.1 Baseline Data of the Study Area	33
3.1.1 Location	33
3.1.2. Topography	34
3.1.3. Hydrogeological characteristics	35
3.1.4. Water resource	36
3.1.5. Geologic characteristics	37
3.1.6. Climate	39
3.1.7. Population	40
3.1.8. Socioeconomic aspects	40
3.1.9. Water harvesting	41
3.2 Study Road Sections	44
3.2.1. Main Study Road Section	44

	<b><u>Page</u></b>
3.2.2. Sub Study Road Section	44
3.3. Field Work and Interviews	46
3.4. Road Engineers Questionnaire	47
3.5. Potential of road rainwater harvesting	47
3.6. Current Road geometric design overview	48
3.7. Main Data List	49

## **CHAPTER FOURE: DATA ANALYSIS AND RESULTS**

4.1. Field Work Results	50
4.1.1. Reconnaissance survey of farmer's initiatives and rainwater harvesting structures and techniques	50
4.1.2 Stakeholders questionnaire results and analysis	55
4.1.2.1. Water Resource	55
4.1.2.2. Water Scarcity Issues and Adaptation	56
4.1.2.3. Climate change risks and rain season change	57
4.1.2.4. Roads & Water Harvesting	58
4.1.2.5. Data analysis of water rights	60
4.1.2.6. Usage & Benefits of RRWH	60
4.1.2.7. The effect of road construction on water way patterns	62
4.1.2.8. Main problems prevent flood water delivery to farms and solution	62
4.1.2.9. Roads water damages & mitigation	63
4.1.2.10. RRW Contamination, source, solution and purify techniques	64
4.1.2.11. Women Rule in Water Resource and Rainwater Harvesting	66
4.1.2.12. Farmers recommendation and future ambition for RRWH	67
4.2 Road engineers questionnaire results and analysis	68
4.2.1. Road Engineers awareness on water harvesting from roads	68
4.2.1.1 Groundwater recharges from roads	70
4.2.1.2 Water harvesting for irrigation or groundwater recharge from the culvert	71
4.2.1.3 Water harvesting for irrigation or groundwater recharge from road side drainage structures	72
4.2.2. Current culvert design understanding	73
4.2.2.1 Location of culverts in road projects	73
4.2.2.2 The culverts type selection in road projects	74
4.2.2.3 The size of culverts design in road projects	75
4.2.2.4 Culvert Inlets Design	76
4.2.2.5 Scour depth and transmitted sedimentation calculation	77
4.2.2.6 Culvert Outlets Design	77
4.2.2.7 Culvert Outlet Spill-Way Design	78
4.2.2.8 Specific Observations from Engineers point of view on culvert design and problems	78
4.2.3. Current Ditches design understanding	81
4.2.3.1 The dimension and shape of side ditches in road projects	81
4.2.3.2 The longitudinal slope of ditches	82
4.2.3.3 The exit of side ditches	82
4.2.3.4 Choose the type of the ditches ( Riprap – Concrete – Earthen)	83

	<b><u>Page</u></b>
4.2.3.5 Specific Observations from Engineers point of view on ditches and road side drainage structure design and problems	84
4.2.4. Irish Crossing(IC) structure design	86
4.2.4.1 Specific Observations from Engineers point of view on Irish crossing structure design and problems	87
4.3. Potential road rainwater harvesting	89
4.3.1. Main Road Potential Rainwater Harvesting	90
4.3.1.1. Case 1 road natural catchment	91
4.3.1.2. Case 2 for 10 km from the main road	93
4.3.1.3. Case 3 Water Harvesting Tank Calculation	97
4.3.1.4. Case 4 RRWH from road surface and side ditches	99
4.3.1.5. Case 5 Water harvesting tank (Bait Al-Shibah)	102
4.3.1.6. Case 6 RRWH from box Culvert outlet	105
4.3.1.7. Case 7 RRWH from 1x 1 box Culvert outlet at station 28+475	106
4.3.2. Water harvesting balance for main road	107
4.3.3 Sub road Potential Rainwater Harvesting	108
4.3.3.1 Case 8 Through the road	108
4.3.3.2 Case 9 Underground Cistern	109
4.3.4 Water harvesting balance for sub road	111
4.4.Current Geometric design	112
4.4.1 Current Geometric design overview of the main road	112
4.4.2 Current Geometric design overview of the sub road	115

## **CHAPTER FIVE: RESULTS AND DISCUSSION**

5.1. Potential RRWH Results	118
5.2 Stakeholders Results	124
5.3 Roads Engineers Results	126
5.4 Geometric and Drainage Design Results	127

## **CHAPTER SIX: CONCIUSION**

6.1 Potential RRWH	132
6.2 Stakeholders:	133
6.3 Roads Engineers & geometric design	133
6.4 Integrated water resource management	134

## **CHAPTER SEVEN: RECOMMENDATION**

7.1 RRWH & Stakeholders	136
7.2 Roads Engineers	136
7.3 Geometric Design	137
7.4 Up scaling RRWH	138
7.5 Further research	139

<b>REFERENCES</b>	140
-------------------	-----

<b>ANNEXES</b>	146
----------------	-----



# **LIST OF FIGURES**

<b><u>Figures</u></b>	<b><u>Title of figures</u></b>	<b><u>Page</u></b>
1	Framework of the research	6
2	Types of road natural catchment	13
3	Typical road catchment profiles that can generate significant runoff	15
4	Summary of the total number of sections in each cell included in the study	33
5	Topographic map of the study area	34
6	hydrogeological map (source: Ministry of Oil and Mineral Resource	35
7	Surface Wells Location	36
8	Fog harvesting unit (pilot project by UNDP's (WGP-AS)	37
9	Geologic map of the study area	38
10	Perception per year according to SamSamWater Climate Tool	39
11	Rainfall IDF Curves	40
12	Domestic animals keeping	41
13	Water Sand Filter	41
14	Terraces System and stone mulching technique	42
15	Under construction tank	43
16	Study Area Map ( Main and Sub-road)	45
17	Some of the interviews with the stakeholders	46
18	Potential RRWH Calculation Methodology	48
19	Water harvesting structures along the main and sub-road	50
20	Left: Open water harvesting tank near coffee terraces, Right:Under construction water harvesting tanks	51
21	Left: shrubs roofed water harvesting tank the farmer use an earth hump to	51
22	Left: Two roofed tanks the farmers use an earth hump to divert the water from the road, Right: Roofed tank with old corrugated panels and the farmer dry check wall and intercept running water from the road surface	52
23	Roofed Dug Cistern near the main road	52
24	Earth humps to divert the surface runoff to the farms	52
25	Right: Earth check steps to divert the surface runoff to the tank by earth hump, Left: Open water harvesting tank and an earth hump	53
26	Underground digged cistern at the inner edge of the stone paved road	53

<b><u>Figures</u></b>	<b><u>Title of figures</u></b>	<b><u>Page</u></b>
27	Rainwater diverting earthen humps and earthen channel	54
28	Stone paved rolling dip to divert rainwater to the tanks	54
29	Earthen channel after the spillway to divert the water to the cisterns	54
30	Longitudinal parallel channel	55
31	Data analysis of water resource in the study area	56
32	Data analysis of water scarcity issues	56
33	Data analysis of scarcity adaptation	57
34	Climate change risks	58
35	Rain season change	58
36	Data analysis of land ownership	59
37	Data analysis of running floods use	59
38	Data analysis of road rainwater harvesting techniques	59
39	Data analysis of water rights from roads	60
40	Data analysis for RRWH usage	61
41	Data analysis of benefits of RRWH	61
42	Data analysis of the effect of road to water way patterns	62
43	Data analysis of problems prevent flood water delivery to farms	62
44	Data analysis of solution of problems prevent flood water delivery to farms	63
45	Data analysis of the damage caused by water from road	64
46	Data analysis of RRW Contamination	64
47	Data analysis of Contamination source	65
48	Data analysis of Contamination solution	66
49	Data analysis of purify techniques	66
50	Data analysis of women rule in water resource and rainwater harvesting	67
51	Data analysis of engineers experience about the effect of RRWH	69
52	Data analysis of groundwater recharge from road as Eng. Point of view	71
53	Data analysis of considerations of water utilizations from culvert as Eng. View	72
54	Data analysis of consideration the water utilizations from road side as Eng. View	73
55	Location of culverts in road projects	74
56	culverts type selection in road projects	75
57	The size of culverts design in road projects	76

<b><u>Figures</u></b>	<b><u>Title of figures</u></b>	<b><u>Page</u></b>
58	Culvert Inlets Design	76
59	Scour depth and transmitted sedimentation calculation	77
60	Culvert Outlets Design	78
61	The dimension and shape of side ditches in road projects	81
62	The longitudinal slope of ditches	82
63	The exit of side ditches	83
64	The type of the ditches	84
65	Watershed of the study area with sub-catchment and culverts locations	89
66	Culverts location along the main study road	91
67	a sample of the road natural catchment area which is calculated by Google-Earth tool	92
68	a sample of the culverts catchment area which is calculated by Google-Earth tool	94
69	Water harvesting tank at the culvert outlet, (left picture) shows the temporary sedimentation and storage pond and the plastic tube to transfer the water to the harvesting tank (right picture)	98
70	These photos show the farmer technique to harvest water a cross the road using dry stone check walls (along the road and skew)	101
71	Road Rainwater Harvesting to Coffee Terraces using Earth Hump and Dry stone check walls	101
72	Road geometric vertical profile section from 2050 to 2800	102
73	Water harvesting tank from road surface in Bait Al-Shibah village	104
74	The earth hump which constructed by the farmer to intercept the road runoff and the right water channel but as the gradient is up-sloped the farmer use a plastic tube to transform the intercepted water to the tank by using in situ pump. It also shows the hill and part of the strip catchments	104
75	Water harvesting pond from culvert outlet	106
76	Water harvesting pond from culvert outlet	107
77	Typical drawing sections for some cisterns (Source : Dr. Ali Al-Ghail - Nama'a NGO)	110
78	Cisterns along the sub road	110
79	Google Earth Profile of the main study road	113
80	Culverts location along the main study road	114
81	Google Earth Profile of the sub study road	116

# LIST OF TABLES

<u>Table</u>	<u>Title of table</u>	<u>Page</u>
1	Main Road natural catchment and intersected sub-catchment areas with number and status of culverts	93
2	Calculation for Potential RRWH at culverts locations for the main road surface and culvert catchment	96
3	Road and culverts catchments percent from sub-catchments area	97
4	Main Road Categories of Horizontal Curves Radii and Design Speed	113
5	Roads structures, functions and their relation to potential rainwater harvesting	128

## Glossary

Cistern: small underground water tank.

Cyclopean concrete: Construction Material consist of 60 % of rock boulders and 40% of Plain Concrete

Ghadhadh: Old and Traditional Material act as Cement Plaster and used to prevent water seepage.

Hump: Man made bump made from local materials such as mud, rocks or plastic bags filled with sand.

Kareef: Local Definition of Small Earth Pond

Maraheg: well-known catchment area mostly from mountain or rocks ridges and directed to agriculture terraces land

Manhal: well-known water resource it may be a spring or seasonal water stream line or water supply points.

Qat: (*Catha Edulis*): a plant used as social habit by chewing it in social groups and it consider as a cash tree,

Rolling Dips: elevated road surface act as humps it may be earth or stone paving

Terraces: Well established earthen embankment with dry stone walls ridges built across a slope to intercept runoff water and reduce erosion and used for planting crops.

Spillway: Water outlet either from the road shoulder, retaining walls heads, side ditch end outlet or from the culvert outlet

Wadi: Valley or water stream line

# **Acronyms and Abbreviations**

<b><u>Symbols</u></b>	<b><u>Descriptions</u></b>
a.s.l.	Above Sea Level
$P_d$ (m)	Average annual rainfall
BC	Before Christ
CSO	Civil Society Organization
°C	Celsius Degree
Cv	Coefficient of variation of annual flow volumes
E	Efficiency Factor
GPS	Global Positioning System
GCRB	General Corporation for Road and Bridge
IDF	Intensity-Duration-Frequency
km	Kilometer
MPWH	Ministry of Public Works and Highways
MOMR	Ministry of Oil and Mineral Resource
mm	Millimeter
$Mm^3$	Million Cubic Meter
m	Meter
PWP	Public Works Project
RWH	Rain Water Harvesting
RAP	Rural Access Program
RRWH	Road Rain Water Harvesting
ROW	Right of Way
RMF	Road Maintenance Fund
RC	Runoff coefficient as fraction
K	Runoff coefficient which depend on the slope and surface or soil type
SFD	Social Fund for Development
$m^2$	Square Meter
$km^2$	Square Kilometer
US\$ (USD)	United State Dollar
UTM	Universal Transverse Mercator Coordinate System
UNDP	United Nation Development Programme
VDS	Vegetated Drainage Systems
WGP-AS	Water Governance Program for Arab States
WEC	Water and Environment Center
W.B	World Bank
YR	Yemeni Riyals

# **CHAPTER ONE**

## **INTRODUCTION**

# CHAPTER ONE

## INTRODUCTION

### *1.1 Background*

Yemen is one of the most water-scarce countries in the world, there is no perennial surface water and the country depends entirely on rainfall, groundwater and flash flooding. And market-led irrigation, which accounts for 90 percent of the total water use. (W.B, 2009).

And Yemen located in a dry and semi-arid region in the south east ( Arabian Peninsula) of the Middle East, is already facing a severe water crisis. Mostly due to high population growth, misguided agricultural development and the growth of Qat, a lack of law enforcement to regulate water use, and a vulnerable climate to climate change, the crisis may soon reach catastrophic levels (Glass, 2010). Also Yemen is facing a water crisis unprecedented in its history.(Lichtenthaeler, Gerhard, 2014). And water scarcity is exacerbated by the rapid growth of the population.

Water rights in Yemen was documented as the source of many internal conflicts and “according to Yemeni researchers, in rural areas some 70–80% of conflicts are water-related” (Kasinof, 2009).

Moreover, Yemen is susceptible to a variety of natural hazards. In recent years, drought has been a common occurrence as rainfall has decreased and temperature has risen. Droughts affect the livelihoods of farmers in particular, but also contribute to a lack of food security for the greater population. (Ismail, 2009).

In addition, Yemen extracts more groundwater than is recharged, causing the water table to drop by an average of 2 meters annually. And the country’s biggest natural resource problem is its falling water table. Rainfall, though heavy in some areas of the



country, and is insufficient to meet Yemen's agricultural needs which take the lion's share of Yemen's water resources, sucking up almost 90 percent. Until the early 1970s, traditional practices ensured a balance between supply and demand of water. After that the introduction of deep tube wells led to a drastic expansion of land under cultivation. In the period from 1970 to 2004, the irrigated area increased tenfold, from 37,000 to 407,000 hectares, 40 percent of which was supplied by deep groundwater aquifers. (HADDEN, 2012).

On the country level, approximately 90% of all water consumed is in the agricultural sector (Nathan Wendt and Laith Aqel, 2012). And based on W.B. the little green book 2013, the agricultural land is about 232,320 km<sup>2</sup> 44 % of the total country land area which equal 528,000 km<sup>2</sup>, while the agricultural irrigated land about 7666.6 km<sup>2</sup> 3.3 % of the agricultural land.

## ***1.2 Problem statement (Research needs)***

Water scarcity, limited water resource and climate change is the main problems facing Yemen farmers (NAPA,2009). Also droughts affect the livelihoods of farmers in particular, and contribute to a lack of food security for most population. (Ismail, 2009). The water challenge facing the Government is how best to control and manage the replenishment and depletion of groundwater resources by improving water harvesting and raise the efficiency in water use (PIP,2006). Likewise, In the study area (Manakha) "people face recurrent droughts, and lack of green cover, while rainwater is the sole source of water, rainwater harvesting establishments have been deployed by local inhabitants as an effective water development and management technique.",(UNDP,2013).

Furthermore, Yemen's topography is known through its rich variety, which is varying from vast plains to steep mountain slopes. And It was stated that Yemen has 71,300 kilometers of roads, according to Ministry of Public Works and Highways MPWH the estimated necessary road network in Yemen is 55,000 kilometers, only 11,735 kilometers of which are constructed paved roads and about of 16,676 kilometers of roads are under execution phase (MPWH). Meanwhile, some roads where located in mountainous areas or along the wadis and are prone to severe damages as a result of flash flood events throughout the country. So by accelerated growth in road industry and due to the role of road to facilitate the way of people living, the negative impact of road industry is modified the natural flow of surface water by concentrating flows at certain points and, in many cases, increasing the speed of flow. These changes can contribute to flooding, soil erosion, channel modification, and siltation of streams depending on local conditions, (W.B, 1997). Thus, These negative impacts can be changed to an assets in term of an integrated roads and water harvesting approach with local communities, specialist roads engineers and road authority.

In addition, It is clear that a substantial portion of the rural road projects pertain to paving, improving or upgrading existing tracks and alignments and adding retaining walls, culverts, Irish crossings, slope stability treatments or safety appurtenances. Where relaxed standards were recommended to avoid the cost of full reconstruction for these facilities, (RAPDM, 2009). Moreover, there are neglecting of road rainwater harvesting among most of road engineers and they only focus on how to lead the runoff out from the road. "In fact engineered water in low standard roads was often treated as a nuisance to be disposed of as cheaply as possible", (Zeedyk, B. 2006).

Despite the above, all efforts are required to preserve Yemen water resources and find alternative water resource such as surface water. And a highlight should be rise to benefit from the indigenous harvested water techniques. Accordingly, any road rainwater harvesting is necessary to adapt to climate change, avoid flood negative impacts and also maintain road assets by integration road construction and findings can be up-scaled easily.

In this thesis Al-Maghrabah - Bab Bahil road and it's rural feeder linked road at Manakha area in Sana'a Governorate, was selected as a case study to optimize the benefits of road rainwater harvesting and evaluate the current situation.

### ***1.3 Research Objectives***

This research will investigate how to optimize the benefits from the running water on the roads through collective tanks and side ditches cisterns, and to determine the effect of road construction on the water harvesting and recharge from road building in Yemen especially in mountainous areas.

The main objective of this research is to:

Optimize the benefits of water from roads for the local communities in socio-economic development (in water storage volume and the beneficial reuse of additional captured water) and for the environment protection focusing on the road of Maghrabah Manakah Bab Bahil Road and the linked rural road Jabal Ekbari and Jabal Awi Road Sana'a Governorate

Sub objectives are:

1. Suggest alternative strategies in geometric road designs to manage water from roads due to Integrated Water & Roads Management.

2. Check the awareness of roads engineers (designers and executioners), decision makers, donors and contractors on the importance of Integrated Water & Roads Management Roads Rainwater Harvesting Concept and the Used Drainage Design Methods.

### ***1.4 Framework of the research***

In order to achieve the objectives of this research a comprehensive approach has been formulated to include literature review, field visit, data collection, analyzing and calculation of potential rainwater harvesting from study road sections. Figure 1 shows the framework of the research.

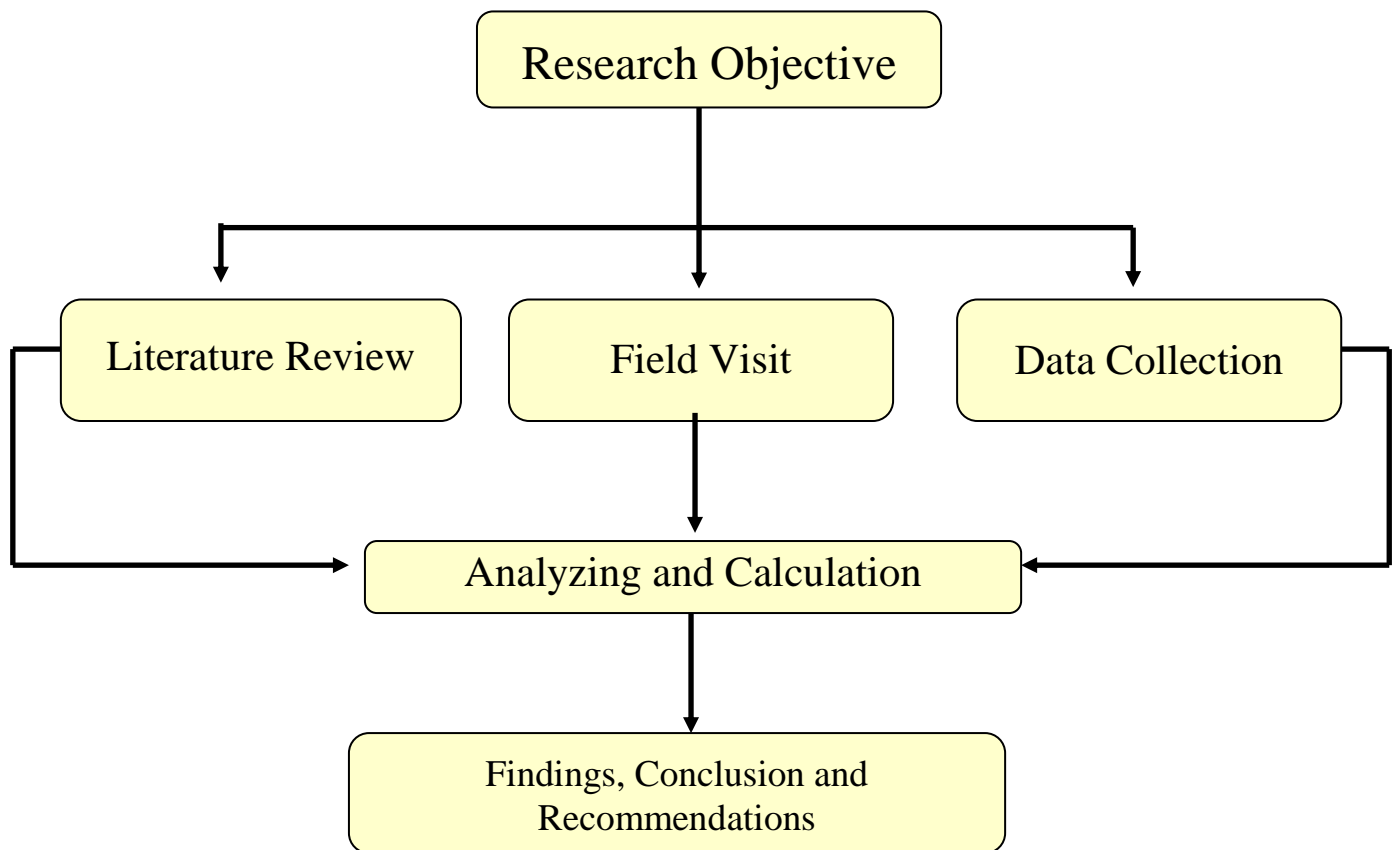

**Figure 1 Framework of the research.**

## ***1.5 Research Organization***

This thesis contains 7 chapters, a brief description of each chapter is given in the following paragraphs:

### **Chapter 1 (Introduction)**

This chapter present background of the research related to Yemen water situation, in addition, problem statement (research needs), research objectives, framework of the research and research organization.

### **Chapter 2 (Literature Review)**

This chapter gives a summary of literature review of water harvesting in general, roads catchment types, road geometric design, road drainage, roads rainwater harvesting and benefits and advantages of RRW.

### **Chapter 3 (Study approach ( Field Work & Data Collection) )**

This chapter describes the study approach including description of the study area, a reconnaissance survey for farmers' initiatives, random farmers explanatory interviews, a questionnaire for road engineers, a calculation of the potential rainwater harvesting, and current road geometric design overview.

### **Chapter 4 (Results and data analysis)**

This chapter presents results and data analysis of findings, analysis of questionnaires, calculation of potential road rainwater harvesting and water harvesting balance and current road geometric design overview for both study roads (main and sub) .

**Chapter 5 (Discussion)**

This chapter gives discussions of the results and presents the lessons learnt of some cases. And present a suggestion of the main road sub-structures and their potential function in RRWH.

**Chapter 6 (Conclusions)**

This chapter gives the main findings of research related the potential RRWH, stakeholders, roads engineers and geometric design.

**Chapter 7 (Recommendations)**

This chapter gives the main recommendation related the potential RRWH, stakeholders, roads engineers and geometric design. Also how to upscale RRWH and future suggested researches.

## **CHAPTER TWO**

# **LITERATURE REVIEW**



## CHAPTER TWO LITERATURE REVIEW

### *2.1 Rainwater Harvesting (General Background)*

Runoff originating from rainfall over a surface was collected and used for various purposes which contained a storage facility to regulate the use of the collected runoff water. The main reason for the development of water-harvesting techniques was the fact that alternative sources of water for drinking and irrigation were not available. (Oweis,et. al., 2004)

The findings of numerous archaeological investigations, made all over the world, strongly indicate that man has long devised ways and means of harvesting (capturing and storing) rainwater, for use on crops or for supplying water to humans and animals. Historically, agricultural methods using surface runoff and rainwater-harvesting techniques were first practiced extensively in dry areas of West Asia and North Africa (WANA) such as in Iraq over 5000 years ago; in India and China water harvesting was used more than 4000 years ago; In southern Jordan, there are indications of early water-harvesting structures which, it is believed, were constructed., over 5000 years ago; (Oweis,et. al., 2004)

“Rainfall harvesting is a term that is widely used, but encompasses a range of very different techniques and technologies, applied across a wide range of scales. At its simplest, it describes the direct capture of rainwater as surface runoff. This may be runoff from roofs and paved areas, harvested at the scale of an individual household for domestic use, surface runoff from small natural catchments, directed to cisterns or tanks for community use, or spate flood flows diverted from a wadi channel to irrigate whole fields. Rainwater harvesting is also used to describe the modification of hydrological

response, to provide additional water for subsurface storage. At a local scale, terracing or micro-catchments may be used to reduce surface runoff and increase infiltration to increase available soil moisture for agricultural use. Alternatively, at catchment scale, groundwater recharge can be enhanced and/or focused – for example through the use of ‘recharge dams’ to retain or retard surface water flows so that infiltration can be enhanced and/or directed to recharge an aquifer system” (Wheater, 2004).

Moreover, a wide variety of rainwater harvesting technologies have been studied and described in detail – from zaï pits in Nigeria to demi-lunes in Niger, through to negarim catchments in the Negev desert of Israel and teras systems in Tunisia (for an overview see e.g. African Development Bank, 2007) – (Ben Kubbinga, 2012)

In Yemen, a system, dating back to at least 1000 BC (Before Christ), diverted runoff water in order to irrigate 20,000 ha, thereby producing agricultural products that may have fed as many as 300,000 people. (Oweis et al. 2004 as cited from Oweis et al. 2001).

Also it was known that for millennia, Yemen farmers have practiced sustainable agriculture using available water and land. Through a myriad of mountain terraces, elaborate water harvesting techniques and community-managed flood and spring irrigation systems ( Lichtenthaeler, Gerhard, 2014).

Rainfall water harvesting is a way to develop and conserve the water resources in Yemen through constructing the dams, and water constructions such as diversion weirs, water concrete tanks and canals, the purpose of these structures to provide surface water for multi-usages.

Van der Gun, et al.,1995, reported that the runoff process is controlled by a large numbers of factors: the main factors are taking into account where the conditions encountered in Yemen:

- Size and shape of the catchment;
- Rainfall characteristics (total depth and distribution in space and time);
- Rates or potential evaporation and evapotranspiration;
- Terrain characteristics of the catchment areas (slopes; occurrence and properties of soils, rock outcrops and vegetation);
- Presence and properties of regional groundwater systems;
- Land use and other human interferences.

## ***2.2 Roads and Water***

Roads alter water movement across the landscape, it can concentrate & accelerate flow, cause soil erosion & gully formation and intercept surface & subsurface flows. In the other hand roads can be managed as tools for saving water, improving vegetative cover and increasing forage yields, in addition to the protection of valuable soils from erosion (Zeedyk, 2006)

To understand the roads and water relation the road catchment, road geometric and road drainage is described in brief as follows:

### ***2.2.1. Road catchment***

Surface water runoff to highway drainage systems is conventionally assumed to derive from the road cross-section. This includes the road surface, verges, curbs and adjacent cuttings or embankments (termed Interior Catchment). Additional surface flow may also be produced by runoff draining to the road from land nearby the highway corridor (termed Exterior Catchment). Exterior catchments can be rural, urban or a combination of both (DMRB, 2004).

Based on (DMRB, 2004). The size, shape and other characteristics of natural catchments, such as gradients, are likely to vary considerably along the highway alignment.

### **2.2.1.1 Catchment Types:**

There are essentially two types of natural catchment that may be encountered alongside roads. (Figure 2 shows types of road natural catchment).

- i. **Valley Catchments:** catchments formed by a well-defined valley, either dry or drained by a watercourse (including ephemeral streams).
- ii. **Strip Catchments:** catchments with no defined valley, forming a strip of fairly uniform width along the highway boundary.

To determine the natural catchment dimensions, the following definitions are applied.

### **2.2.1.2 Catchment width:**

- a) Valley catchments: is the distance between the top end of the catchment and the top of the cutting, or the pavement edge, measured along the valley, perpendicular to the ground contours (distance A-B in Figure 2).
- b) Strip catchments is the distance between the highest point of the catchment and the top of the cutting, or the pavement edge (distance C-D in Figure 2).

### **2.2.1.3 Catchment length:**

This is defined as the distance of natural catchment adjacent to the highway boundary, measured parallel to the road.

In flat areas definition of the natural catchment boundary is not always obvious, and engineering judgment should be applied. The maximum catchment width should not exceed 10km.

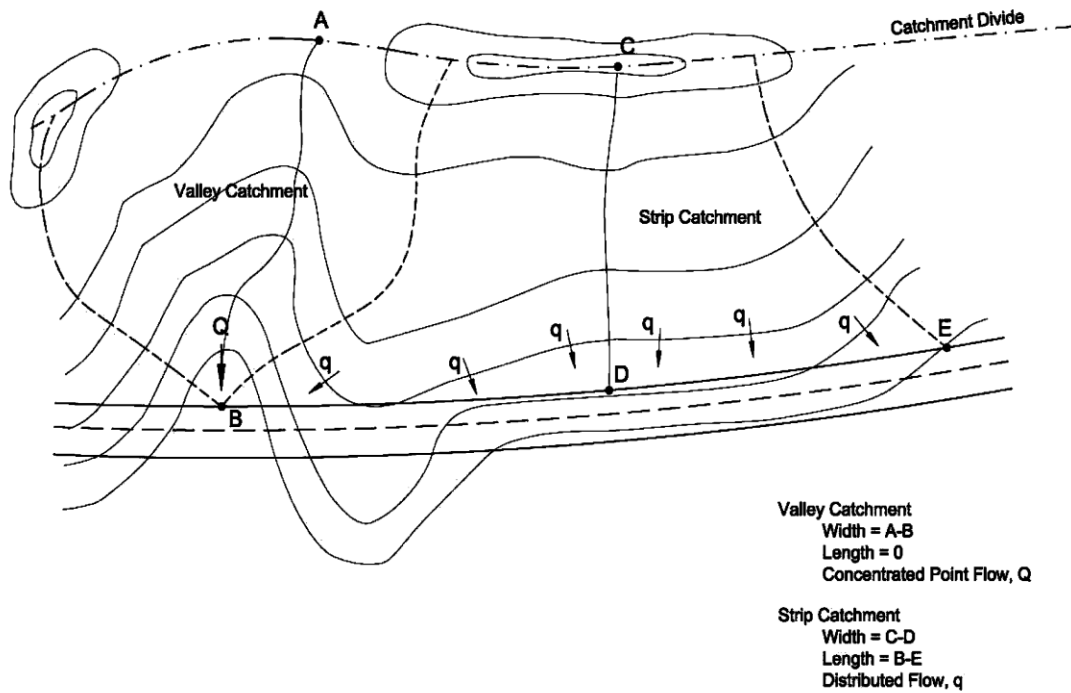

**Figure 2 types of road natural catchment**

(Source: DMRB, Vo. 4 Sec. 2, Part 1 HA 106/04, *Drainage of Runoff from Natural Catchment*)

The flood prone areas can be identifying by a checklist as given below:

- i. Road configuration:
  - 1- Low points/areas (sag);
  - 2- Inner areas of bends in road alignment where accumulation of flow can occur due to adjacent catchment;
  - 3- Connection with other roadways (e.g. slip roads) that can act as a drainage pathway;
- ii. Road catchment features: that can produce significant runoff which refer to two situations (roads in cutting and in filling (shallow embankments)), this need to be considered in conjunction with the checklist for the identification of flood-prone areas:
  - 1- large fields adjacent to the road (Examples A.1, B.1 and C.1 in Figure 3);

- 2- slopes intercepted by the road (Examples A.2 and A.3 in Figure 3 );
  - 3- areas of well-defined stream catchment (even if stream is ephemeral) producing concentrated flows;
  - 4- presence of natural springs.
- iii. For existing road structures schemes :
- 1- Poor condition of existing cut-off ditches, land drainage and culverts (i.e. overgrown vegetation in ditches, blockages in culverts and ditches, collapsed drains);
  - 2- Level of outfalls that do not allow free discharge;
  - 3- Poor condition of road drainage system (blockages, siltation);
  - 4- Signs of erosion (gullies) in cutting slopes; poor establishment of vegetative protection in steep cuttings; in cultivated land, furrows running in the direction of the slope (rather than transversely).

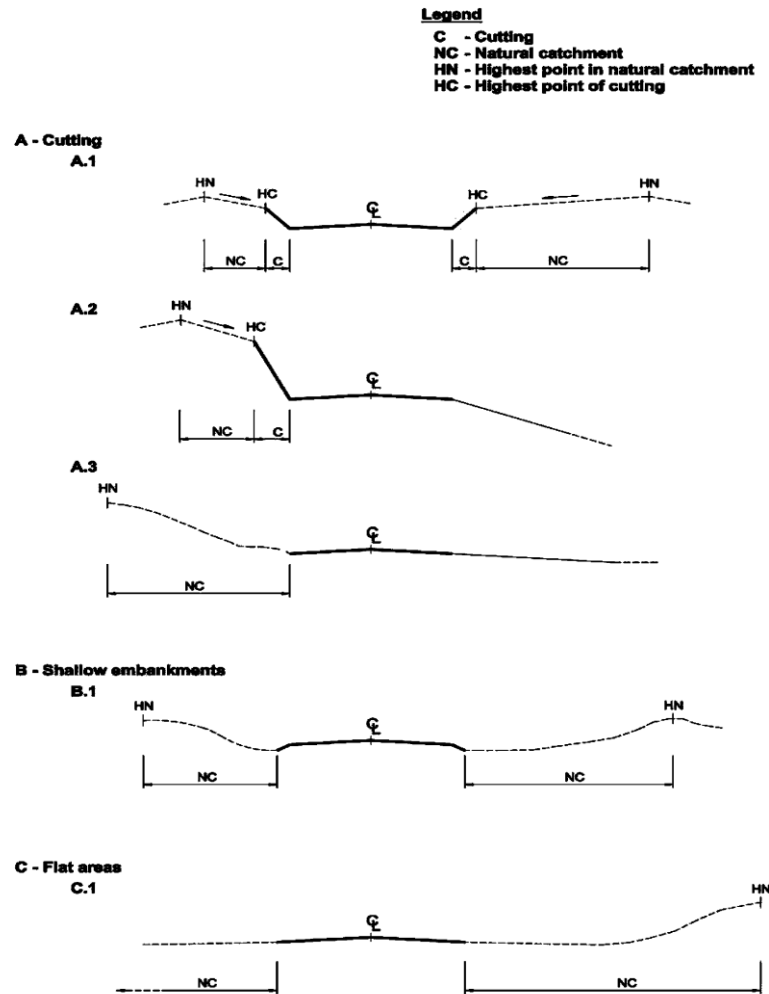

**Figure 3 Typical road catchment profiles that can generate significant runoff**

(Source: DMRB, Vo. 4 Sec. 2, Part 1 HA 106/04, *Drainage of Runoff from Natural Catchment*)

### 2.2.2. Roads geometric design:

Geometric design is technical matters which consider a lot of design parameters such as horizontal radius, cross slope, superelevation, gradient, sight distance, stopping sight distance and design speed.

To understand the geometric design role there is a need to understand, introduce and discuss the general design requirements for road drainage infrastructure, The Department of Transport and Main Roads, State of Queensland, provided a Road Drainage Manual, July 2015, gives definitions of the design requirements as follows:

- a) **Design considerations:** encompass all aspects, issues, functionality, expectations, demands, constraints, risk and cost that need to be appropriately addressed, or to be taken into account, in order to satisfy design criteria and determine trade-offs.
- b) **Design controls:** are aspects of the road environment or project that cannot be changed, or are extremely difficult to change and, therefore, place some restriction or control on the design.
- c) **Design criteria:** set the expected level of achievement or conformance for relevant design parameters or design inputs. The design criteria ensure that the end result can be judged and defended.
- d) **Design standards:** set approved or prescribed values or limits for specific elements of design or set procedures and/or guides that must be followed. A design standard with respect to road drainage would be the use of the Rational Method to determine the runoff from a small rural catchment.

Both design criteria and design standards set the mandatory limits designers must work within and/or achieve.

In Yemen almost all rural roads had adapted design standard to reduce the high construction cost and to sidestep the social conflicts that may occur in case of changing the existing route alignment due to nature of the mountainous terrain so the designer exerted great care to enhance the existing route and apply standards relaxation in order to avoid unnecessary improvement on existing alignments, but also to mitigate the safety problems and costly design, (RAPDM, 2009).

The road geometric parameters had effect on drainage system and consequently the potential road rainwater harvesting. The road features that may affect landscape



drainage are: grade, width, cross section, berm, plan form, drainage systems, and stream crossing, (Zeedyk, B.,2006).

The main geometric features that may affect the drainage system can be described as follows:

**- Vertical alignments**

A gentle longitudinal gradient for road vertical alignment improves the road surface drainage and facilitates the discharge of water from the sections of the road surface with limited cross-slope, (Johannessen, Bjørn, 2008).

As the levels of side drains are often set out relative to the level of the road shoulder, the road gradient is replicated in the side drains, (Johannessen, Bjørn, 2008).

The road geometry and vertical alignments should ensure that outfall levels are achievable; and subgrade drainage can discharge above the design flood level of any outfall watercourses which may influence the minimum height of embankments above watercourses and the depth of cuttings to avoid sag curves low spots which cannot be drained. (DMRB, HD 33/06, May 2006).

Also consideration of drainage of the carriageway surface is particularly important in areas of flat longitudinal gradient and at rollovers. Where longitudinal gradients are flat it is better to avoid rollovers completely by adoption of relatively straight alignments with balanced cross falls. (TD 9 (DMRB 6.1.1))

Drainage can then be affected over the edge of the carriageway to channels, combined surface water and ground water drains or some other form of linear drainage collector. Gullies may be required at very close spacing on flat gradients. (TD 9 (DMRB 6.1.1))

Careful consideration should be given to road profiling and the net gradients which result from combination of cross fall and long fall. These may be best indicated by contoured drawings of the required carriageway surface. (TD 16 (DMRB 6.2.3))

**- Camber and (Cross-slopes or Superelevation).**

The camber is the slope from either side of the center line towards the road shoulders.

On most roads, the camber is roof shaped with the highest point at the road center line, with a descending gradient towards the road shoulders. On narrower local roads, the camber may be constructed as a continuous slope from one side of the road to the other. This is referred to as a cross-slope, (Johannessen, Bjørn, 2008).

The minimum rate of cross-slope applicable to traveled way is determined by drainage needs which range from 1.5 percent for high-type surface to 2.0 percent for low-type surface and may increase to 2.5 percent in some areas with intense rain,(AASHTO, 2001).

On sharp curves, the camber is often substituted with a super-elevation which leads the water to the inside of the curve. The super-elevation is installed with a gradual change of the road cross section from a camber shape to a road surface shaped with a cross slope, (Johannessen, Bjørn, 2008).

Cross-slopes are also used to achieve good driving dynamics. To counter the centrifugal forces exerted on a vehicle maneuverings a curve, a cross-slope is installed with a downward slope towards the center of the curve. When roads have a grade towards the cut side of a slope, the surface water needs to be led

away to a side drain and eventually through some form of crossroad drainage arrangement such as culverts or splashes, (Johannessen, Bjørn, 2008).

Areas of super elevation change require careful consideration. Where super elevation is applied or removed the cross fall on the carriageway may be insufficient for drainage purposes without assistance from the longitudinal gradient of the road. TD 9 (DMRB 6.1.1) suggests that a longitudinal gradient of 0.5% should be regarded as the minimum in these cases. This is the net longitudinal gradient including the effects of the application of super elevation acting against the gradient where super elevation is:

- a) Applied on a downhill gradient; or
- b) Removed on an uphill gradient.

To achieve a resultant gradient of 0.5% may require a design line gradient of 1.5%. Alternatively the super elevation area may be moved to a different location by revision of the horizontal alignment, or in extreme cases a rolling crown may be applied. It is essential that a coordinated analysis of the horizontal and vertical alignments with reference to surface water drainage is carried out before alignments are fixed. It should also be borne in mind that permissible standards adopted in design may not be achieved in practice as a consequence of the construction tolerances permissible for road levels.

Four methods are used for transition the pavement to a superelevated cross section which include: (1) revolving a traveled way with normal cross slopes about the centerline profile, (2) revolving a traveled way with normal cross slopes about the inside-edge profile, (3) revolving a traveled way with normal cross slopes about the outside-edge profile, and (4) revolving a straight cross slopes traveled way about the outside-edge profile.

The profile reference line controls for the roadway's vertical alignment through the horizontal curve.

Method (1) of rotation about the centerline is the most adaptable, while the method (2) rotation about inside-edge is preferable where the lower edge profile is a major control, as for drainage.

Also methods (3) and (4) are advantageous in that the upper-edge profile – the edge most noticeable to drivers – retains the smoothness of the control profile.

Thus the shape and direction of the centerline profile may determine the preferred method for attaining superelevation.

Minimum transition grades (AASHTO, 2001) addressed two potential pavement surface drainage problems are of concern in the superelevation transition section.

1. The potential lack of adequate longitudinal grade which occurs when the grade axis of rotation is equal to, but opposite in sign to, the effective relative gradient. Its results in the edge of pavement having negligible longitudinal grade, which can lead to poor pavement surface drainage.
2. Inadequate lateral drainage due to negligible cross slope during pavement rotation which occurs in the transition section where the cross slope of the outside lane varies from an adverse slope at the normal cross slope rate to a superelevated slope at the normal cross slope rate. This length of the transition section includes the tangent runoff section and an equal length of the runoff section.

Two techniques can be used to alleviate these two potential drainage problems, provide a minimum profile grade in the transition section and provide a minimum edge of pavement grade in the transition section.

Both techniques can be incorporated in the design by use of the following grade criteria:

1. Maintain minimum profile grade of 0.5 percent through the transition section.
2. Maintain minimum edge of pavement grade of 0.2 percent through the transition section.

### ***2.2.3. Roads drainage:***

In road construction history drainage structures, design and considerations were practiced and developed by road agencies and engineers. A review of some road drainage design manuals were described briefly to shed the light on the importance and use of these drainage structures and to give general perspective of such structures, their advantage and requirements, For example,

(AASHTO, 2001), indicated that ‘Highway drainage facilities carry water across the right-of-way and remove storm water from the roadway itself’. As the drainage facilities include bridges, culverts, channels, curbs, gutters, and various types of drains.

The DMRB, HD 33/06, May 2006, reported the following major objectives in trunk roads drainage:

- i) The speedy removal of surface water to provide safety and minimum nuisance;
- ii) Provision of effective sub-surface drainage to maximize longevity of the pavement and its associated earthworks; and
- iii) Minimization of the impact of the runoff on the receiving environment.

Also (Zeedyk, 2006) reported that the road drainage system may consist of an array of several multi-purposes ditch types such as (road or borrow ditch, lead-off; furrow or wing ditch, cross drain and lead-out ditch, lead-in ditch, and interceptor or cut-off ditch). There are also other elements affect the road drainage such as cross drains (rolling dip, flat land drain and piped drains or culverts).

(Johannessen, Bjørn, 2008), stated that it is essential to allow water to flow off and away from the road as quickly as possible. This is achieved by a system consisting of the road surface drainage systems, side drains and mitre drains, road embankments in a flood prone terrain, catch-water drains, scour checks, culverts, bridges and drifts

In addition, RAP 2009, described the drainage works which designed to serve the highway as follows: roadside ditches, roadside barriers, chutes to collect platform runoff in high fill, pipe culverts, Irish Crossings which provided to convey flow on the road from one side of the road to the other. Flow can be wadi flow or side ditches, and bumps (typically range between 5-15cm in height) which placed across the surface of the road to direct water to agricultural lands for water harvesting purposes.

(Knoop L., et. al., 2012), reported that the efficient and a well-designed drainage system is the most important part of rural road construction and can reduce maintenance works costs.

The Department of Transport and Main Roads, State of Queensland, provided a Road Drainage Manual, July 2015, reported that **‘the drainage system becomes an important and integral consideration in the planning and design of road infrastructure to provide an appropriate and economic drainage system’**. In addition, all road projects drainage systems should consider the following:

- Flood immunity, accessibility, conveyance, effects of public and private property and should be acceptable to the community;
- Protection of the roadway asset and safety of all road users
- Pollutant discharge to receiving waters and land degradation due to erosion and sedimentation during road construction, operation and maintenance
- Any effect on habitats or movement for terrestrial and aquatic flora and fauna

### ***2.3. Roads rainwater harvesting***

The road rainwater harvesting was defined by different authors either indirectly as retention area or directly as road runoff harvesting. For example, Tsunokawa, Koji; Hoban, Christopher [editors] (1997), citing data from Lantran's (1995) diary, states that 'in a survey conducted by the World Bank, it was established that simple small-scale water retention structures along large and small rural roads could make a significant difference to water supplies during the dry periods. The study identified three basic types of structures along roads that, with minor modifications, could become retention areas, with water useable for agricultural purposes. These were:

- i) Standard storm water catch basins-deepened and with controlled drainage added;
- ii) Various forms of check-dams or fords, to slow drainage, creating ponding; and
- iii) Various other damming devices, such as sluice gates, raised box culverts and dams'

Also, (Nigigi, 2003), pointed out that farmers in most semi-arid areas adopt and adapt road runoff RWH system to be used for diverting the runoff which generated from distinct catchments such as roads, footpaths, cattle tracks, grazing areas and homesteads, among other external catchments into their croplands.

(Zeedyk, 2006), reported that road drainage features can be directed to buffered infiltration sites and the additional benefit of harvested water can be realized by landowners, while the road is protected from erosion and maintenance costs is reduced.

Moreover, (Ben Kubbinga, 2012), said that road runoff harvesting (RRH), in most cases, emanates from the tinkering mind of innovative smallholder farmers, which can be in two general forms. The first is collecting runoff from road surfaces with roadside drains, and the second is road runoff harvesting through a culvert.

Furthermore, there are several ways and techniques used as road rainwater harvesting and are described in some manuals, handbooks and guidance for example:

The Design Manual for Roads and Bridges (DMRB, HA 103/06, 2006), provided guidance on Vegetated Drainage Systems VDS for Highway Runoff on how vegetated drainage systems may be used to convey, store and treat highway runoff before it outfalls to the receiving waters. They contain a significant element of vegetation, where according to their nature, they are part of the surrounding landscape and can contribute to the nature conservation or landscape amenity value of an area. And they are designed to be used especially in highway to supplement or replace conventional drainage systems. The VDS systems can be defined as:

- (i) Those that convey water, such as swales and grassed channels; or
- (ii) Those that treat water while it flows slowly through the system such as wetlands and infiltration basins; or
- (iii) Those that treat water at rest, such as ponds.

(Nissen-Petersen, 2006) provided a handbook for technicians and farmers on harvesting rainwater from roads. It describes four types of rainwater harvesting from roads, namely earth dams (murrum pits, small pans, large pans, ponds, charco dams, hillside dams and valley dams), tanks (hemispherical tanks built of (burnt bricks; ant-hill soil, lime, sand and cement and ferro-cement), cylindrical underground tanks, berkads and rectangular water tanks), subsurface dams (water in sand reservoirs, floodwater passing roads, hand-dug wells, soil subsurface dams, weirs, sand dams and sand harvesting) and run-off farming (drainage from roads by engineers & farmers, soil bunds, gullies and macro-irrigation), which farmers can construct themselves for a minimum of investment.

Zeedyk, B. (2006), addresses in a handbook for water harvesting from low-standard rural roads techniques for recognizing road water harvesting opportunities, ways of



managing roads to reduce off-site erosion and even ways of managing roads to restore damaged sites.

RAP, 2009, prepared Rural Roads Design Manual which described the techniques of water harvesting and groundwater recharge practiced along the roads which involves the diversion and collection of water to surface impoundment for storage or immediate utilization as follow:

- Collection: (side ditches and concrete edges).
- Interception / Diversion Structures: (bumps across road to divert water to either side, culverts, Irish crossings, road embankment, and interception dikes)
- Discharge Structures: (chutes, cascades, and channels), chutes are used at culvert outlets and at ditches discharge points to control and prevent embankment erosion.
- Discharge Points: (earth or concrete ponds for storage / recharge, and direct discharge to agricultural lands for immediate utilization by farmers).
- Protection Requirements: (road surface protection at bumps to resist scour / erosion, and embankment protection using grouted riprap or gabions).
- Within the farm, by create depressions around trees and line them with rocks or mulch to retain moisture, arrange brick or flagstone paving to direct water to plants, and dig furrows and channels to direct water to crops.

Steenbergen, F. van, et al, 2014 & Frank van Steenbergen, et al. 2014, give overview on how to combine water and roads for better use of surface and ground water, erosion mitigation and reduce road maintenance costs. And suggest a number of sets of techniques which will optimize the use of roads for water, as follow:

- 1- Combining cross drainage/ side drains with recharge and storage
- 2- Borrow pits and dugout ponds - beneficial use of excavation material

- 3- Clever road foundations
- 4- Spring capture
- 5- Water spreading weirs/ sand dams combined with river crossings
- 6- Sand harvesting
- 7- Protection against erosion from roads
- 8- Roads as flood control mechanisms
- 9- Water harvesting from road surfaces
- 10- Ford/irish crossing for retaining groundwater,
- 11- Roads body as retention dams / small retention ponds

A combination of the methods and techniques may be used due to the site location and the available materials & land and construction cost. Moreover, some road drainage structures may act as multi-purposes structures such as water convey, retention, sedimentation, soil conservation, environment protection, pollution reduction and water harvesting from/along roads.

The research collect, review and summarize the different road drainage structures, techniques of water harvesting from roads, storage and recharge facilities from multi sources and from some cases in Yemen with some suggestions (as mentioned in table 5).

There are a lot of practices and initiatives from framers to be use and benefit from road rainwater floods, due to the need of the water as it is a vital resource for agriculture and domestic need depends in the region characteristics and climate properties. Where it is already practiced by several farmers from different countries such as: Kenya, Tanzania, Uganda, China, Nairobi, Brazil, Ethiopia and Yemen.

For example, Musyoka Muindu from Mwingi District, Kenya, harvested the water from tar road near his farm from a culvert under the road throw a main channels crossing

neighbor land with another channel that leads runoff from hillside, (Mutunga and Critchley, 2001). And he used an initial fanya chini structure (a zigzag channel with the earth thrown downslope) and fanya juu structure (embankment above the channel) to distribute the harvested water along his farm. With an extra pond to store the excess harvested water. Also (Ben Kubbinga, 2012) conducted further study on the same case to study the long-term impact of road runoff harvesting.

Another example Ms. Florence Akol from Bukedea County, Kumi District, Uganda, (Mutunga and Critchley, 2001) harvested water from road side ditches using diversion ditches and stored in semi-circulated infiltration ditches first, then water flows through infiltration basins to irrigate banana plantation and its conserved by mulching. This will increase banana yields and associated farm income over 50%. In addition, ecological benefits include soil loss reduction through control of concentrated road runoff.

Furthermore, rainwater run-off from the Nairobi-Mombasa highway is diverted into an earth dam at Salama, which provides water for livestock, brick-making and forestry without any erosion (Nissen-Petersen, 2006).

In Kenya, 'murrām' pits are situated next to roads where the murrām (excavated soil) is used in the road construction, then using murrām pits (also known as borrow pits) which is the most common technique to harvest runoff water from roads in the region. This only involves excavation and transport of soil, which can be easily done - manually or with oxen and digging two trenches water that can be easily diverted water from the road to the pits. The slope of the trench should ideally have a gradient of 3%, in order to prevent sedimentation in the pits. Moreover, a spillway – protected by stones – can divert the surplus water to its original course. The best way to determine the optimum height for the spillways is to build them in stages (Knoop, et. al., 2012).

In China, over 50,000 rainwater harvesting tanks were constructed for irrigation purposes during dry periods. The underground tanks have been built along roads and use drainage water. The tanks are cylindrical, with a volume of 30 m<sup>3</sup>, are 25 cm wall thick and have a small opening on the top. The construction materials used include limestone rocks, bricks and sand. The tanks have two off-take pipes: a smaller one for irrigation purposes and a bigger one for sediment removal. Also, manual cleaning should be carried out every 3 to 5 years. The tanks have supported the cultivation of sugar cane, tobacco, and mulberry. In addition, the yields per hectare and rural incomes have increased as a result (Knoop, et. al., 2012).

Another example can be found in Brazil, where over 500 infiltration ponds were built along highways to collect road runoff for groundwater recharge under the so-called “Water Way” initiative. The soil in these ponds filters the water and removes pollutants. The average capacity of the ponds is 4000 m<sup>3</sup> (Knoop, et. al., 2012)..

In Ethiopia, Until the year 2013/2014, there was no systematic approach for road water harvesting in Tigray, as elsewhere in Ethiopia. There were however sporadic practices implemented as part of the soil and water conservation efforts. Since the year 2013/2014, efforts were made to introduce road water harvesting in a more systematic manner. And a case study for the Freweign-Hawzien-Abreha Weatsbeha-Wukro route in Tigray, Northern Ethiopia (64 kilometer length) were conducted. The main technologies and approaches implemented were: (a) use of pits/ponds to collect road side drainage, (b) channeling water from culverts and road side drainage into series of deep trenches, (c) use of borrow pits (for surface water storage and groundwater recharge), (d) channeling water from culverts and road sides to farm lands, (e) shallow groundwater development upstream of Irish bridges and fords and (f) reuse of borrow pits for water storage and groundwater recharge. The study concluded that about

1.34 Million Cubic meter of surface water could be harvested without major investment. At the same time water-related road maintenance costs can be reduced, which now stand at 35%, (Kifle Woldearegay et al., 2015).

In Yemen there is history of huge creativity in retaining water and a lot of practical innovative techniques were observed along some rural roads by farmers and sometimes by road engineers.

It was found that road water harvesting has been successfully introduced in a number of places along the national roads network and in some rural feeder roads.

In general, in areas where water is very scarce, there are large opportunities to harvest the water from the road surface, rolling dips, road shoulders, culverts, side-drains, spring capture, borrow pits locations for a variety of purposes.

In Yemen there is no previous studies related the road rainwater harvesting. However, there are some of the techniques already presented in the country and the farmers owned land within the right of the road are the main founders due to the dire need of water for multi-purposes use, and they use simple and local materials to do that. Another initiative is done by the road engineers or contractors either by coincidence such as using borrows pit excavation location as a recharge pond at the end of the road construction or in purpose such as using the road body to act as a recharge dam. While some techniques are merged by the engineers and farmers in some locations such as spring capturing.

## ***2.4 Benefits and advantages of road water harvesting***

The main benefits from road water harvesting include the increase in storage capacity of the local water buffer and the reduction of surface runoff, which reduce the erosion of the road and soil.

In Brazil's Water Way initiative, groundwater recharge increased from 25% to 31% and the surface runoff decreased from 65% to 57%. And the main constraints are to avoid the using of water harvested from roads for domestic purposes, as it could be polluted by motor oil, tar, rubber, .etc; and road-side structures such as culverts can turn into large gullies (Knoop, et. al., 2012)

Roads can supply huge volumes of water for livestock, irrigation, forestry, construction works, etc. Also, provided the harvested water which can be stored until it can be used in the following dry season. Other indirect advantages of water harvesting from roads is the uses of water volumes collected from roads for supply: The tree nurseries, woodlots, orchards and vegetative fencing of fields and homesteads, manufacturing of burnt bricks, concrete blocks, culverts and other building materials that can be sold, (Nissen-Petersen,2006).

More benefit is, the sale of water to neighbors for watering their livestock, construction works, ... etc., and raising ducks, geese, fish and bees in or near open water reservoirs. Also, sale of sand harvested from weirs and sand dams in gullies and riverbeds. In addition to the recharge of hand-dug wells near subsurface dams, weirs and sand dams in riverbeds, where domestic water can be drawn. However, using run-off water from tarmac roads for domestic use is not advisable due to the risk of contamination by tar, oil, rubber, etc. Farther, the agricultural production is increased from fields irrigated by road run-off water.

Teweldebrihan (2014), concluded that harvesting runoff from roads cannot only be used as additional water source for supplementary irrigation but also minimizes the damage caused by flood on farms along the road side as well as on the rural roads, which in turn reduces the cost of maintenance of the road itself for damage that is caused by excess runoff. She also concluded that lack of proper integration of road construction into the

broader rural agricultural livelihoods has resulted in various negative impacts: soil erosion and gully formation in cultivated land, flooding of agricultural and inhabited areas, and reduced recharge of groundwater, but it also has a huge potential to be a key contributor to the enhancement of the livelihoods. The three major recommendations are:

- (1) for the betterment of the impacts, it is suggested that Roads for water harvesting and multiple uses be mainstreamed in educational systems
- (2) There should be integration between relevant institutions and authorities as well as regional and zonal line offices in making future road development plans. And
- (3) Awareness generation should be done to encourage farmers utilize the runoff from roads for productive purposes. Moreover, technical assistance and training's needs to be delivered at grass-root level.

## **CHAPTER THREE**

### **STUDY APPROACH**



## CHAPTER THREE

# STUDY APPROACH

In order to achieve the objectives of this research a comprehensive approach has been done to formulate and defined the data. The work includes:

1- Baseline data of study area

Description of the study area and study main and sub roads,

2- Field works which consist of:

2.1- A reconnaissance survey to record the farmers' initiatives for water harvesting structures and constructed culverts,

2.2- Random explanatory farmers' sample interviews,

2.3- Conducting semi structured questionnaire, to evaluate the awareness, water rights, climate change, pollution, women role and rainwater harvesting activities along the study road sections.

2.4- Conducting questionnaire for specialist engineers: A questionnaire have been implemented and filled by the specialist's engineers who are responsible for the design, supervision and maintenance of roads, including information about:

- Water harvesting from roads concept and how to benefit from it.
- Design standards of road water drainage structures.

3- Collecting data and calculating the potential rainwater harvesting from road

- A calculation of the potential rainwater harvesting for main road 36 km length, and sub-road were conducted, with some detailed cases and water harvesting balance calculation was done for the surveyed water harvesting structures along the main and sub-road.

4- Conducting a road geometric design review of the main road and sub-road

### 3.1 Baseline Data of the Study Area

#### 3.1.1 Location

The study area is a part of rural road at Manakhah district at the west highlands of Yemen which called Haraz Mountain. It locates at distance about 120 km west of Sana'a Capital of Yemen, along Sana'a - Hodiedah road. Manakhah district is a part of Sana'a Governorate with total area of 700 km<sup>2</sup>. The study road area was choosing in the route from Maghrabah –Manakah to Bab Bahil with a catchment area of 73 km<sup>2</sup>, which represent a small part of Wadi Surdud catchment (2700 km<sup>2</sup>), as one part of the Red Sea (Tihama) main catchments. Figure 4 shows the study area location.

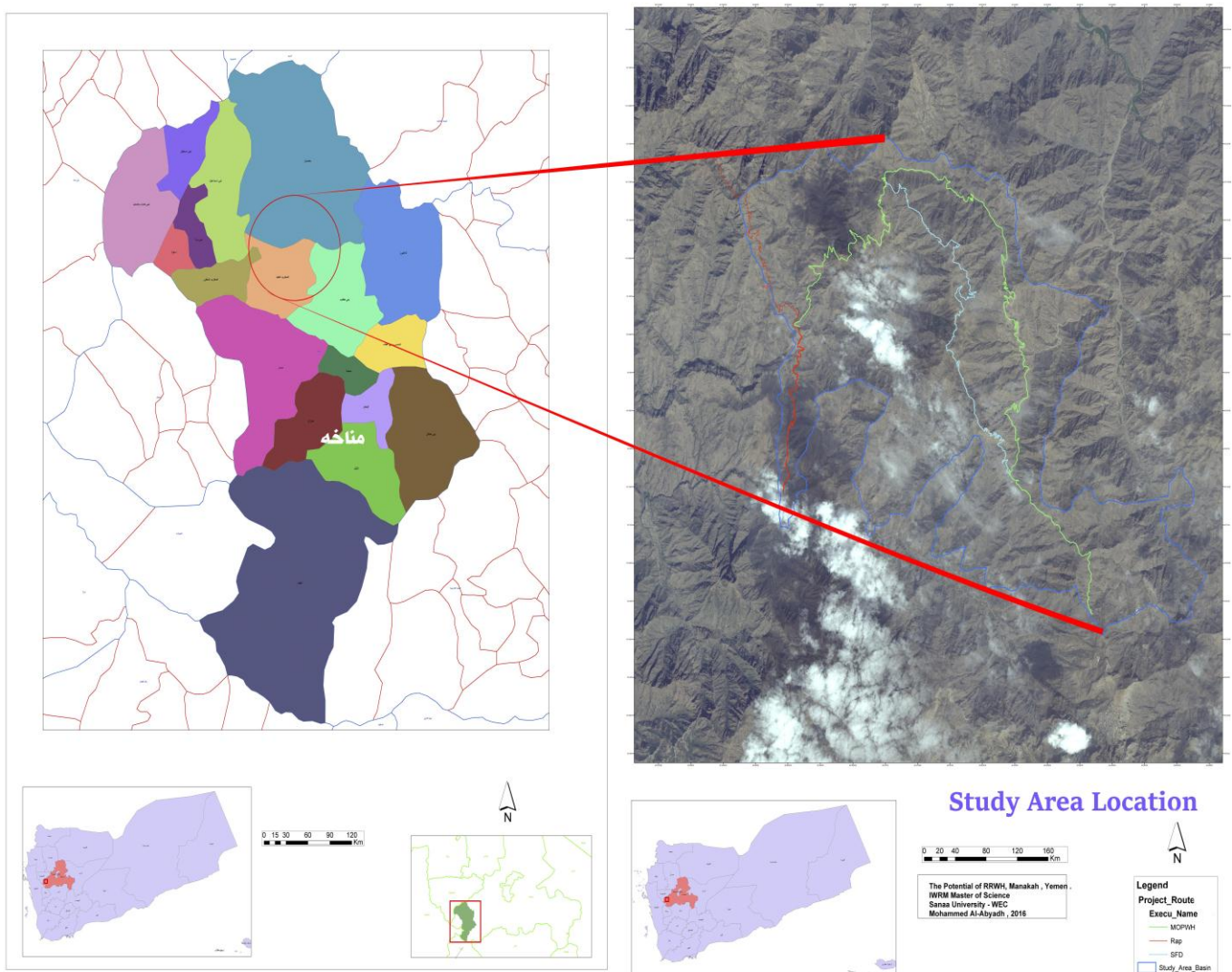

Figure 4 Study area location

### 3.1.2. Topography

Manakhah district has a large dissected plateau marked with rugged mountains and volcanoes. This western escarpment forms a transitional zone between the Tihama and the upland plateau, which it is steep and rugged. Thousands of small villages are situated on rocky outcroppings of this western slopes, that supports crop cultivation via an elaborate terracing system, (Wenner, 1991). Figure 5 shows the topographic map of the study area. The topographic of the study area is change from steep to moderate with different slopes and passes some sub plateau and sub- wadi's streams, and then reach the main wadi of Surdud.

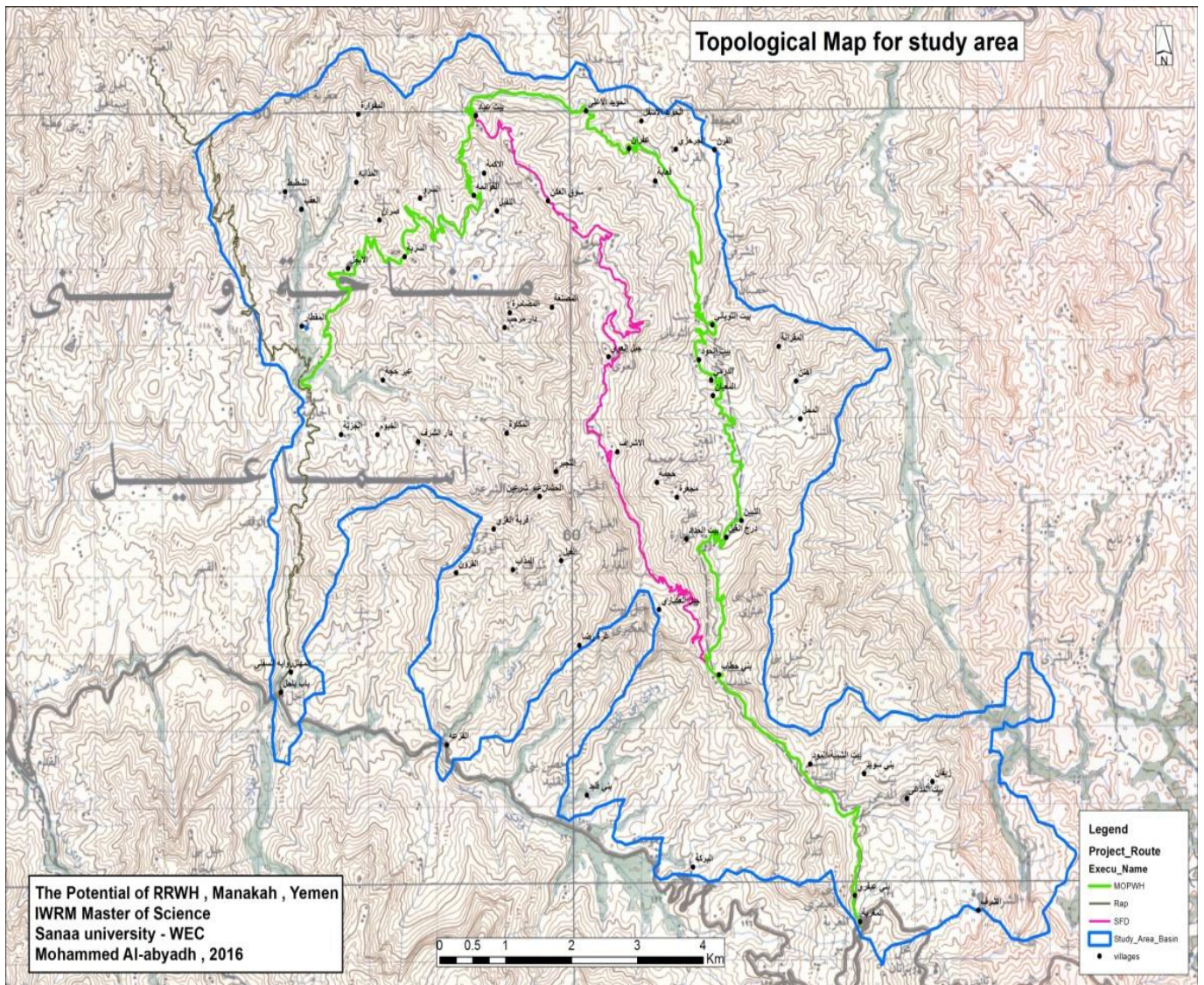

Figure 5 Topographic map of the study area

### 3.1.3. Hydrogeological characteristics

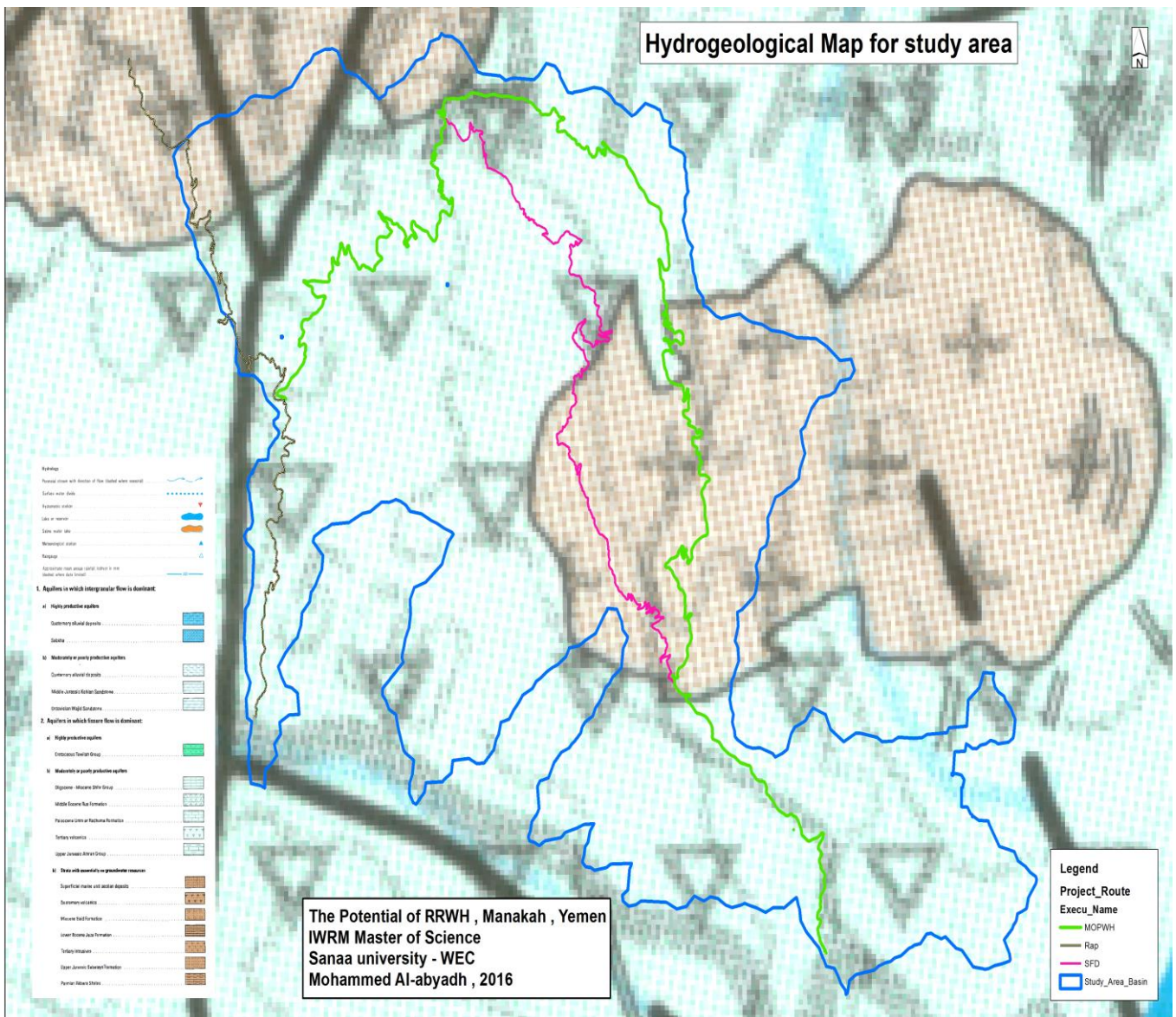

Figure 6 hydrogeological map

(source: Ministry of Oil and Mineral Resource, )

From the hydrogeological map produced by the (Ministry of Oil and Mineral Resource) the main aquifers in the study area are:

**Tertiary Volcanic** considered moderately or poorly productive aquifers in which fissure flow is dominant.

**Tertiary Intrusive:** considered as strata with essentially no groundwater resources which consist of granites, granodiorites and gabbros, mostly cropping out in a broad band along the western margins of the Yemen highlands region. Primary permeability is

likely to be negligible in the intrusives because of the close crystalline structure of the rock, but limited groundwater flow may occur in shallow cracks and joints opened by weathering. However, it is not likely to be generally sufficient to sustain flow to a well.

Figure 6 shows the hydrogeologic map of the study area

### 3.1.4. Water resource

Rainfall: is the main source of water.

Springs: which is recharged during rainy season and last for few periods in dry seasons.

Surface wells: for depth about 15 m which found in the sub wadi's such as wadi Bani Khatab, wadi Tabyen, Bait Thowbani, wadi Iryaha and Howiad. Figure 7 shows the surface wells locations along the study roads.

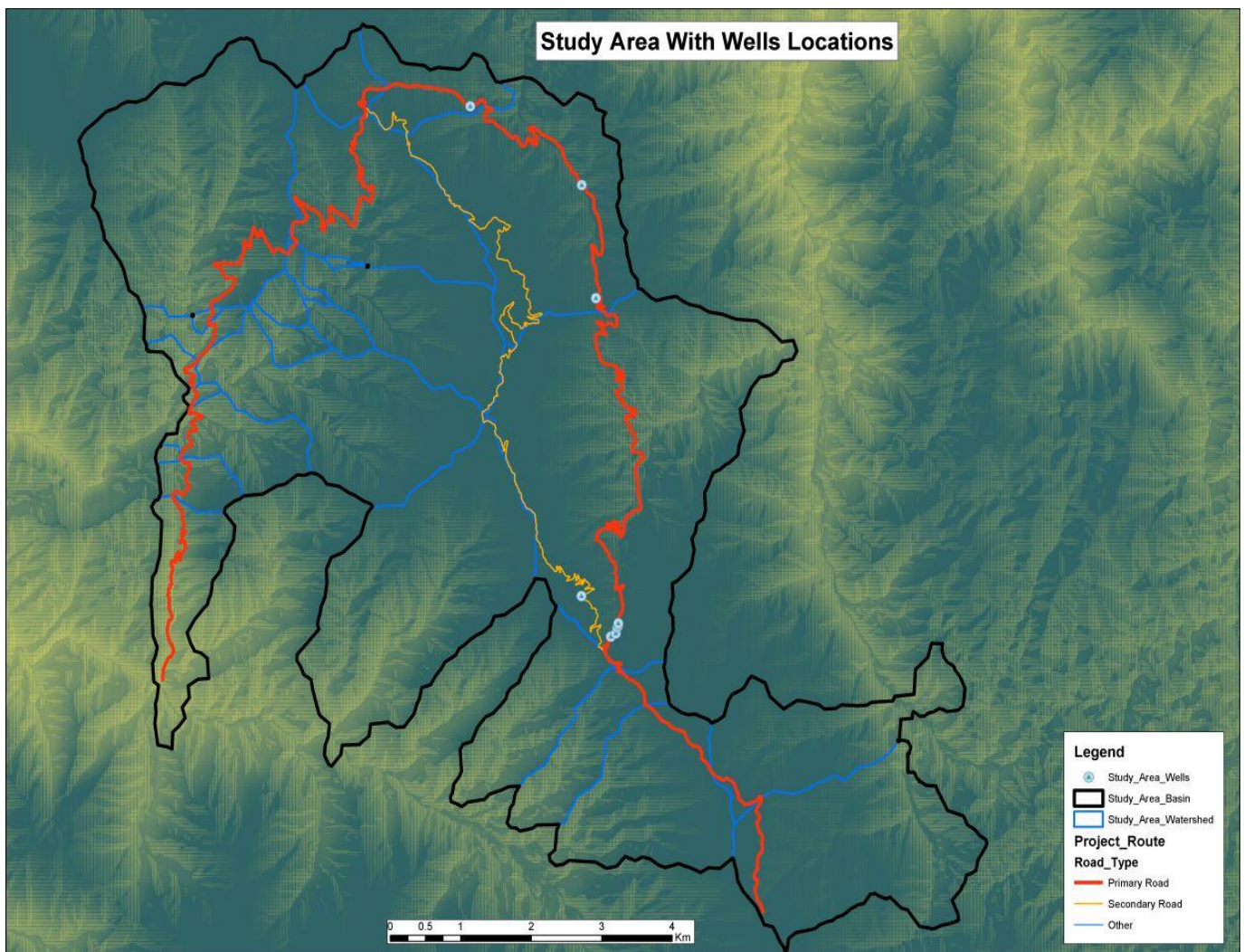

Figure 7 Surface Wells Location

Harvested Water: the running floods stored in water harvesting structures considered as water resources during drought periods.

Fog harvesting: in the sub road a pilot units of fog harvesting were installed and funded by some agencies such as the National Foundation for Watershed Management – in partnership/ support with UNDP’s Water Governance Program for Arab States (WGP-AS) –partnered with CSOs in Manakha like Al-Nama Development Association for Coffee Producers,



Figure 8 Fog harvesting unit (pilot project by UNDP’s (WGP-AS)

### ***3.1.5. Geologic characteristics***

Manakhah Escarpment is characterized by high and rugged mountainous ridges, which have a variety of slopes in all courses. It is an area of active geological deformation (tectonics) and moderate earthquakes activity. The boundaries between the mountains are almost matched with the tectonic situation. Manakhah area is seen to be entirely built up from volcanic rocks from the Cenozoic Epoch, Tertiary Period, as shown on Figure 9. These volcanic rocks include bedded alkali flows and pyroclastic rocks including rhyolite, comendite, pantellerite, trachyte, andesite, basalt and ankermite (Shukri and Basta, 1955) Cited from MPWH, RMF, 2010.

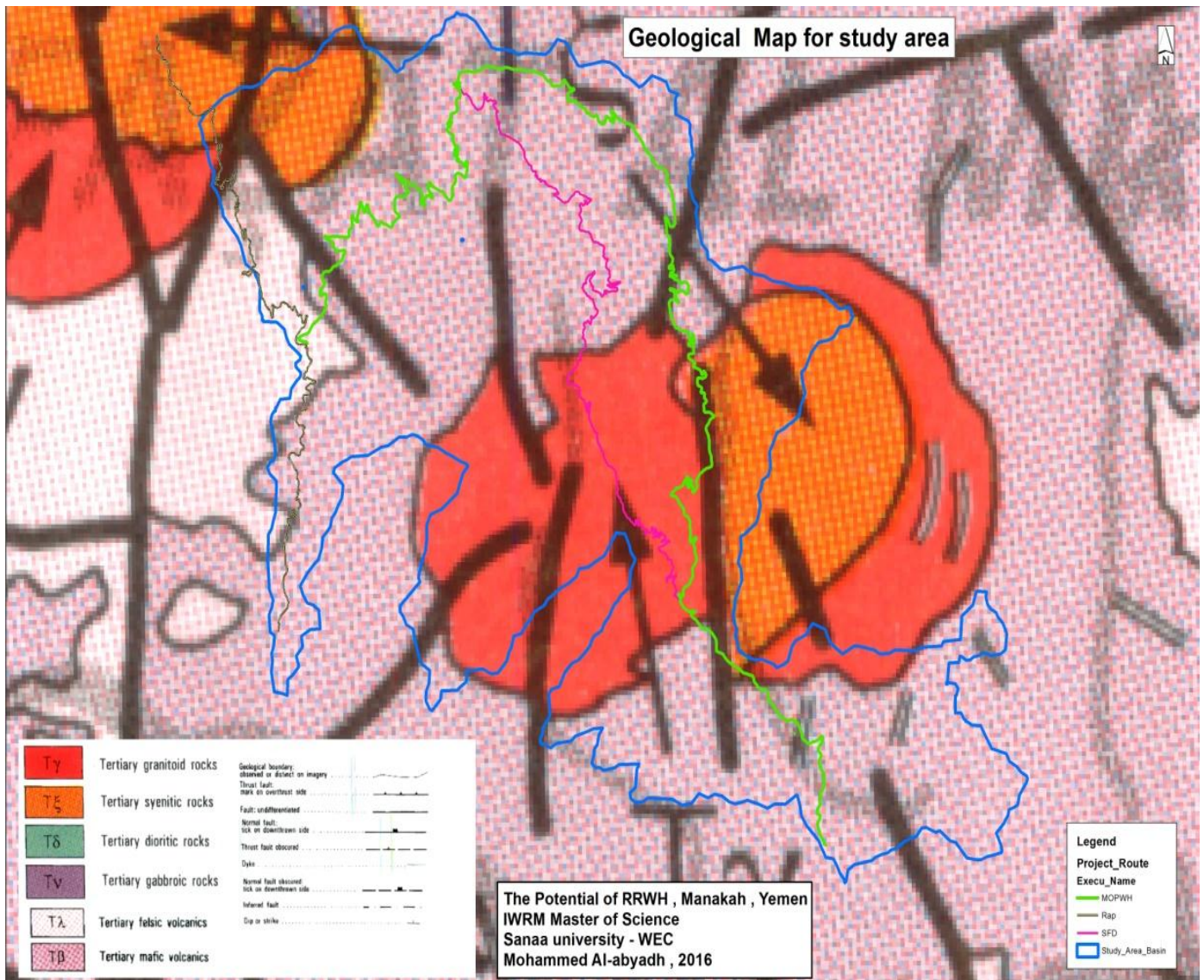

**Figure 9** Geologic map of the study area (source: Ministry of Oil and Mineral Resource, )

The study main and sub road had been projected in Arc Map and geologic map from the (Ministry of Oil and Mineral Resource) were geo-referenced and seen that the main road passed a variety of geologic features as follows: the first part from the start to a distance of 4.500 km the tertiary mafic volcanics, the tertiary granitoid rocks from 4.500 to 13.500 km, tertiary mafic volcanics from 13.500 to 20.00 km, tertiary felsic volcanics from 20.00 to 29.500 and tertiary mafic volcanics from 29.500 to 36.500.

While the sub road passed a variety of geologic features as follows: the first part from the start to a distance of 8 km the tertiary granitod rocks, from 8 to 16 km, tertiary mafic volcanics.

### 3.1.6. Climate

The Haraz Mountains have a mild climate with changing humidity and lie in the border zone of the ever-green mist belt (the coffee plantation zone) and on the edge of the highlands. The climate is characterized by two rainy seasons; the spring rainy season is usually in April/May and the summer rainy season in July/August.

Temperatures vary only marginally during the course of the year. The average difference between the warmest (June/July) and the coldest (December/January) months is only 2-3oC with a mean annual temperature of 16.6oC (Kasperek Verlag, 2007). The general climatic pattern of study areas is sub-tropical arid to semi-arid region. The mean annual precipitation is estimated using SamSamWater Climate Tool to 371 mm for the year and the average monthly rainfall is illustrated in Figure 10.

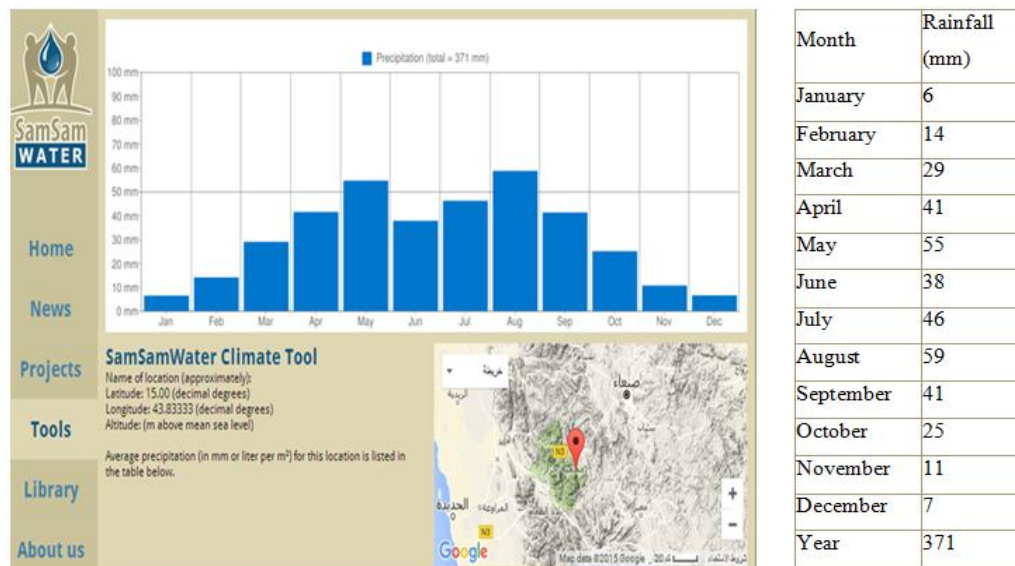

Source of data: [CRU CL 2.0](#) which is described in [New, M., Lister, D., Hulme, M. and Makin, I., 2002: A high-resolution data set of surface climate over global land areas. Climate Research 21:1-25](#) and [AquaStat](#).

**Figure 10 Perception per year according to SamSamWater Climate Tool**



According to rainfall records of Manakah rainfall station, for more than 10 years the IDF curves were drawn by General Cooperation for Roads and Bridges (GCRB) and illustrated in figure 11.

**Rainfall Intensity [mm/h], Duration [min.] & Frequency [years] at Manakha Area**

T (min)	2	5	10	25	50	100
5	61.90	87.89	105.10	126.85	142.98	159.00
10	42.55	60.43	72.26	87.21	98.30	109.31
15	35.46	50.35	60.22	72.68	81.92	91.09
30	24.50	34.79	41.60	50.21	56.60	62.94
60	16.12	22.89	27.37	33.03	37.24	41.41
1440	1.34	1.91	2.28	2.75	3.10	3.45

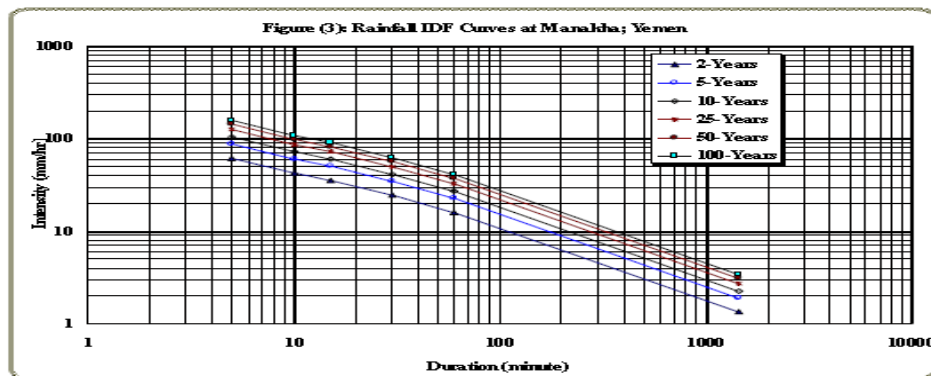

**Figure11 Rainfall IDF Curves**

(Source: Hydrological Manual for Yemen, Annexes, GCRB, )

The catchment yield at the gauged station of Wadi Surdud catchment area 2700 km<sup>2</sup> as follow: mean annual rainfall or precipitation is 440 mm, mean annual runoff is 69.3 Mm<sup>3</sup> (29.2 mm) , the coefficient of variation of annual flow volumes (Cv) is 0.22 , and runoff coefficient as fraction (RC) is 0.066 , Van der Gun, et al.,1995

### **3.1.7. Population**

The population of Manakah district about 78,932 inhabitants 39,991 females and 38,941 males (Census, 2004).

### **3.1.8. Socioeconomic aspects**

Most population in the project area lives under poverty line. Agricultural activities including farming, forestry, livestock and rain fed crops is vulnerable to fluctuations in rainfall and climate change.

The majority of people depend on rain fed agriculture during rainy season and they cultivate maize, barley, wheat and millet. Also, farmers grow coffee trees, *qat* and some fruits. Moreover, they cultivate cash crops like tomatoes in winter season. They also keep bees, domestic animals, mine rocks and sand as building material beside the official employment. See figure 12.



**Figure 12 Domestic animals keeping**



**Figure 13 Water Sand Filter**

Women and girls usually spend considerable amount of time in fetching water for household use, and animal drinking which affect girls' time for education. See Figure (13).

### ***3.1.9. Water harvesting***

The local people living near the road already practice road water harvesting using several techniques.

The Yemeni farmers in area of Manakha as in Al-Magharibah Al-U'lia, Bani Khattab and other nearby parts have innovated several and indigenous systems related to water harvest. Such innovations have served the purpose for long while adhering to the region's dry climate conditions, making use of the available water from rain, springs and other sources. Such tactics are as variable as the water sources in addition to making good use of fog harvest as part of the traditional methods to plant coffee trees in cylinder-shaped stone holes along with stone covers over the farmland, (UNDP, 2013).

There is a lot of water harvesting techniques and types in the all area of Manakha due to the scarcity of water in the entire area include:

#### 1-Terraces harvesting techniques:

It is one of the unique, ancient and well-built system as contoured intervals where they use dry stone walls with small head wall (*berm*) to benefit from the available sloped land, and to harvest and retain water for agriculture. The man made terraces on the slopes of the Yemen mountains to protect the soils from being washed away; let the rains to be easily infiltrating into the ploughed soils and it is largely used for evaportraspiration of the cultivated fields. Also, the protecting walls from a barrier to overland flow, (Van der Gun, et al.,1995). Furthermore, Locals in this area use another technique in terraces by using dry stone mulching around the coffee trees to keep the soil moisture and to harvest the fog by condense it around the trees roots. Figure 14 shows an example of terraces system in the study area and stone mulching technique.



**Figure 14 Terraces System and stone mulching technique.**

#### 2- Rain Water harvesting structures:

There are a lot of water harvesting structures in the study area due to the scarcity and the severe need of water. The structures include public ponds, private open / roofed tanks, and underground cisterns using traditional hand tools to excavate the soft rocks as caves and use cement coating to prevent the seepage of water.

Some of the rain water harvesting structures construction were supported from some agencies such as: Social Fund for Development (SFD), where SFD had implemented a

number of projects either as public tender or as community contracting for private cisterns. The SFD projects include: (open public tank in Bani Khatab village, 8 ponds in Bani Khatab area , and 82 private tank (gave main materials such as cement, iron, cover, and pipes with technical support as each beneficiary excavate and construct their own tank) in the villages of (Bait Al-Thobani, Bait Al-Hood, Al-Darmy, and AlHalhal). Also, Public Works Project (PWP) had implemented an open public tank with sand filter in Al-Awi village. Furthermore, National Foundation for Watershed Management – in partnership/ support with UNDP’s Water Governance Program for Arab States (WGP-AS), and partnered with Al-Nama Development Association for Coffee Producers, whom rehabilitate some water harvesting tanks and underground cisterns. Moreover, many of the existing rainwater techniques in Manakha either have been destroyed over time, and require rehabilitation, or the newly underway establishments that are still incomplete due to lack of financial resources, and still non-operational. (Figure 15 shows an example of under construction water tank). Also, some rainwater harvesting establishments lack proper watershed management to secure diversion of sufficient floods. (UNDP, 2013).



**Figure 15 Under construction tank**

## ***3.2 Study Road Sections***

The study roads consist of two routes, the first is main road which is under construction with 36 Km long and the second (sub-study road) is rural feeder tertiary road with stone paved sections of 8 Km long; both of them are described below:

### ***3.2.1. Main Study Road Section***

The selected main road route is Maghrabah Manakah Bab-Bahil Road in the Sana'a governorate, passes a crosses part of Haraz highlands and linked with the Sana'a – Hodiada Main road at the start and end points of the route. It has a length about 36 Km and start from the Souk (Market) of Maghrabah Manakah (latitude: 15.097250°, longitude: 43.736450°) and elevation of 2000m (a.s.l.) and passes through several villages ( Bait Shiabah, Bani Katab, Bait Hadad, Draji Al-Gail, Al-Tabyan, Al-Me'an, Al-Dhola'a, Al-Darmy, Bait Al-Hood, Bait Al-Thobani, Al-Zaih, Al-Ghawanima, Al-Jazabah), and end at Bab-Bahil (latitude: 15.123880°, longitude: 43.657072°) at an elevation of 1200 m (a.s.l.).

The road is earth dirt road surface under construction phase to be an asphalted road and the road surface is in subgrade phase. It is deteriorated by the water erosion that forms some longitudinal gullies. The road passes through multiple topography formation which is change from steep to moderate with different slopes, and it crosses some sub plateau and several small water's fall streams and wadi's such as wadi Bani Khatab, wadi Tabyen, wadi Bait Thowbani, wadi Iryaha and Howiad wadi. The land use along the road contain scattered villages, agriculture terraces, rock outcrops , hill slopes, and pastures & regional plants cover.

### ***3.2.2. Sub Study Road section***

The sub study road route is a feeder rural road (Jabal Ekbari and Jabal Awi Road – Hasaban subdistrict – Manakah district – Sana'a Governorate). . It has a length about 16

Km and starts from Bani Khatab (latitude: 15.127734°, longitude: 43.715219°) and elevation of 1861m (a.s.l.), and intersect the main study road at a station of 5 km from the start station and intersect it at kilometer 20.5 at the end (latitude: 15.190629°, longitude: 43.683351°) at an elevation of 1877m (a.s.l.).

The road is earth dirt surface in semi flat sections with scattered stone paved section (cumulative paved length about 8 Km) at the steep, hard and rough slopes. The road passing in a mountainous terrain vary from moderate to steep slopes and it pass in the top of (Jabal Al-Awi) mountain with several different slopes. It follows the existing landscape of the surrounding mountains and crosses multi agriculture terraces which have been planted with coffee, qat and rainfed plants.



**Figure 16 Study Area Map ( Main and Sub-road)**

### ***3.3. Field Work and Interviews***

A reconnaissance survey during field visit were conducted to record the farmers' initiatives, rainwater harvesting structures & techniques, constructed culverts and direct observations were noticed. The field visit was accompanied with random explanatory farmers' sample interviews during walk with a semi-structured questionnaire (Annex 1). This questionnaire will evaluate the stakeholder's awareness, water rights, climate change, pollution, women role and rainwater harvesting activities along the study road sections, (Figure 16 shows some of the interviews with the stakeholders).



**Figure 17** Some of the interviews with the stakeholders

### ***3.4. Road Engineers Questionnaire***

A structured questionnaire (Annex 2) distributed among 60 random road engineers in MPWH, RMF, GCRB, RAP, SFD and related roads departments who are responsible for the design, supervision and maintenance of roads. So it is exploratory sample to be filled by them to find out the general methods used for water related structures designs in roads, to measure their awareness about water harvesting aspects from roads, and to obtain their specific observation about drainage structures problems. Only 45 samples were filed and return back.

The Excel program and SPSS had been used to analyze the collected data.

### ***3.5. Potential of road rainwater harvesting***

To achieve the research objective of development water storage volume (additional captured water) to improve socio-economic of local communities and for the environment protection, a calculation of the potential rainwater harvesting from main road and sub-road were conducted using the road natural catchment and road surface catchment. And, also some detailed cases which had been observed along the study main road and sub road were described. Also water harvesting balance calculation were done for the surveyed water harvesting structures.

Figure (18) illustrates the potential road rainwater harvesting calculation methodology. The main assumptions were addressed for all cases such as the formula of calculation, the average annual rainfall and the efficiency factor. Meanwhile, the runoff coefficient was determined for each individual case.



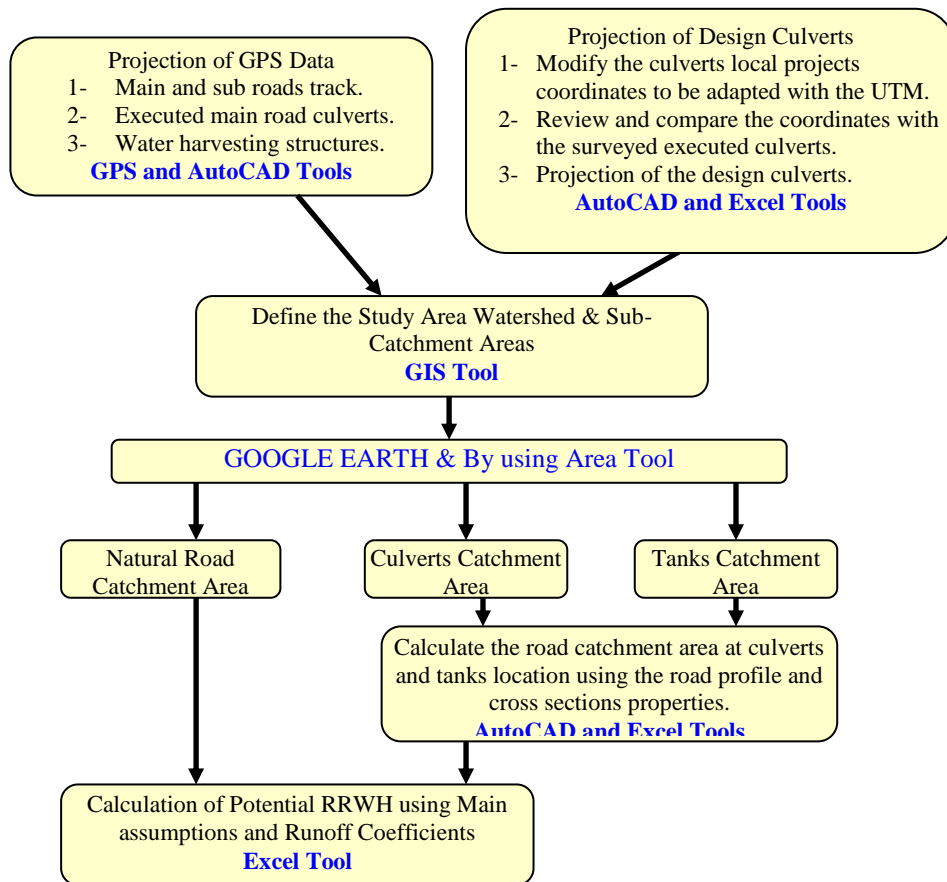

**Figure 18 Potential RRWH Calculation Methodology**

The main assumptions are as follows:

The formula of Ben Kubbinga, 2012 was used to calculate the harvested rainwater.

$$\text{Water Harvested (m}^3\text{)} = \text{Catchment Area (m}^2\text{)} * P_d \text{ (m)} * K * E$$

Where :  $P_d$  (m): The average annual rainfall, it is estimated 371 mm as predicted from SAM SAM tool.

$K$  : Runoff coefficient which depend on the slope and surface or soil type.

$E$  : Efficiency Factor which which assumed to be 70%.

### ***3.6. Current Road geometric design overview***

To define the role of geometric design in water harvesting, a review of the main road current geometric design were conducted, some technical issues which observed during the field visit were addressed and some of the geometric parameters that may affect the road drainage were discussed.

### ***3.7. Main Data List***

- 1- Reconnaissance survey of water harvesting structures along the main road.
- 2- Reconnaissance survey of water harvesting structures along the sub-road.
- 3- Questionnaire analysis of stakeholder interviews.
- 4- Engineers questionnaire analysis.
- 5- Geometric design of the main road.

## **CHAPTER FOUR**

# **RESULTS AND DATA ANALYSIS**

## CHAPTER FOUR RESULTS AND DATA ANALYSIS

### 4.1. Field Work Results

#### 4.1.1. Reconnaissance survey of farmer's initiatives and rainwater harvesting structures and techniques

Along the study of main and sub roads sections there are a number of water harvesting structures with multiple sizes either opened or roofed with single skin panels roofs, old corrugated zinc panels roofs, wood shrubs roofs or with natural soft rock cave roofs which is found around dig cisterns. Figure (19) shows the location of water harvesting structures along the study roads, and annex 3 and annex 4 list the water harvesting structures location and type along the main and sub road.

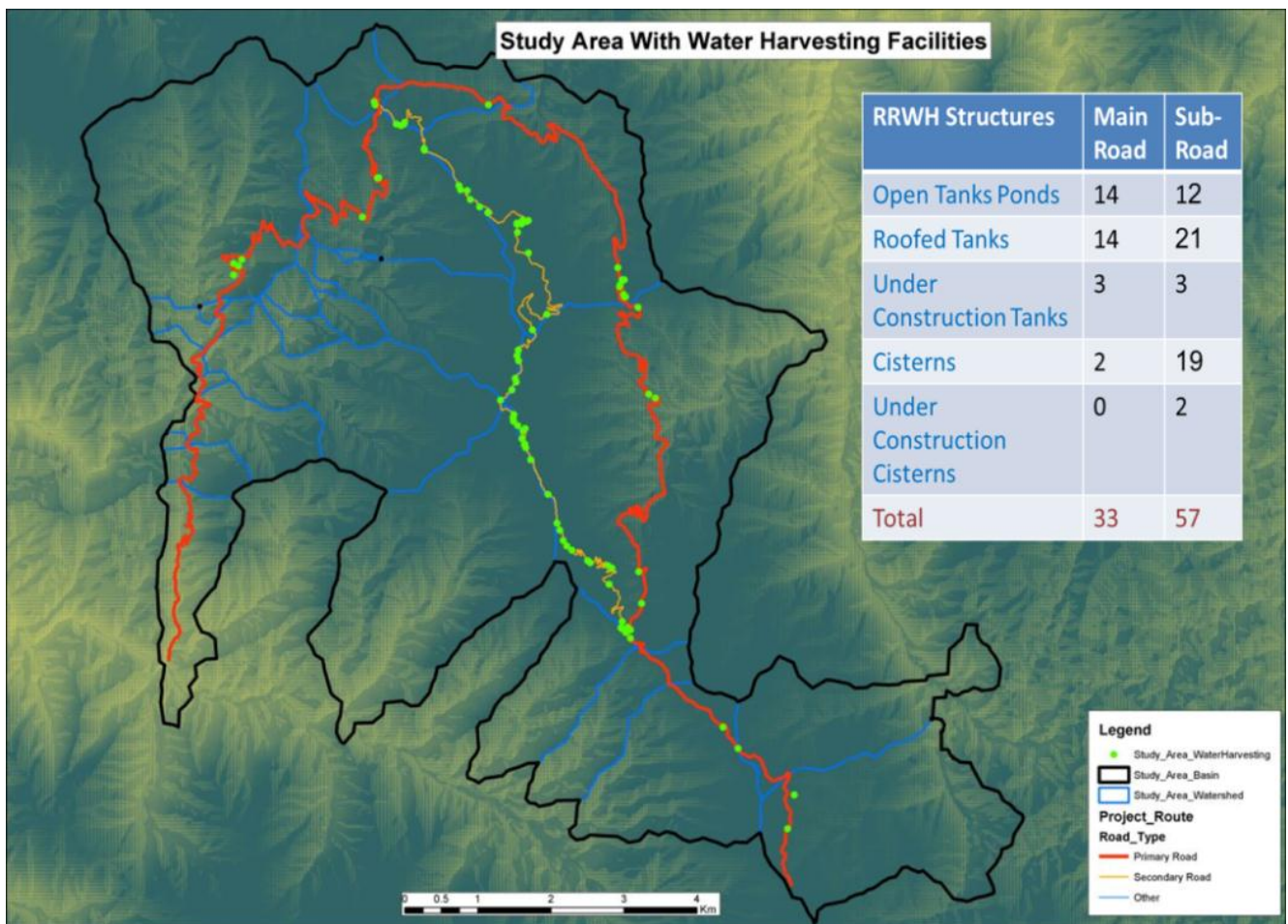

Figure 19 Water harvesting structures along the main and sub-road

People already harvest water from roads surface and from culverts outlets by different methods such as: earthen humps and small cascade steps which are used to divert the collected surface road water either to water harvesting structures or farms. The farmers used sand and dry stone check walls to build humps and cascade steps. Figures (20 to 26) show some of the water harvesting structures along the main and sub road.



**Figure 20 Left: Open water harvesting tank near coffee terraces, Right: Under construction water harvesting tanks**



**Figure 21 Left: shrubs roofed water harvesting tank the farmer use an earth hump to divert the water from the road surface. Right: old corrugated roofed tank the farmer use parallel side ditch to divert the water from the road.**

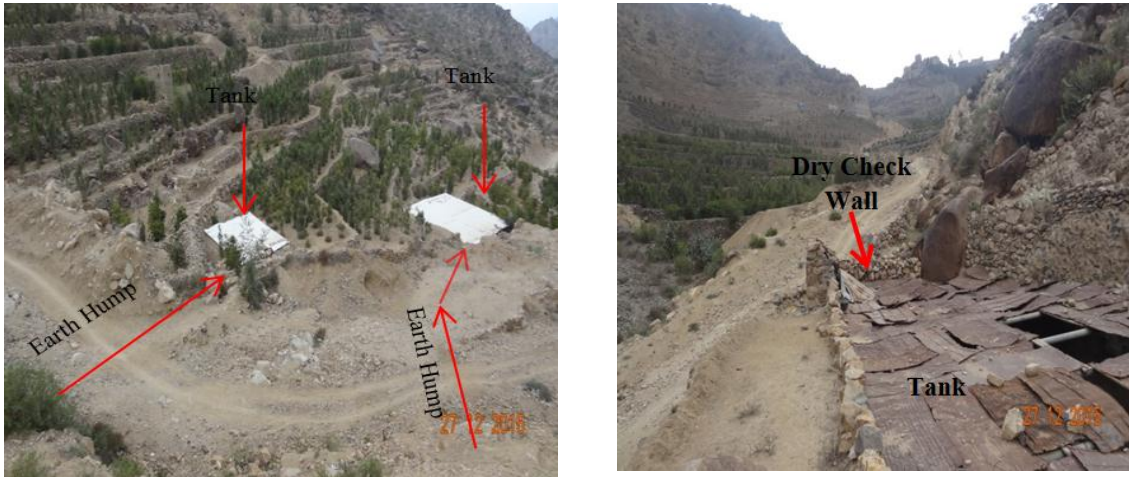

**Figure 22 Left: Two roofed tanks the farmers use an earth hump to divert the water from the road, Right: Roofed tank with old corrugated panels and the farmer dry check wall and intercept running water from the road surface**

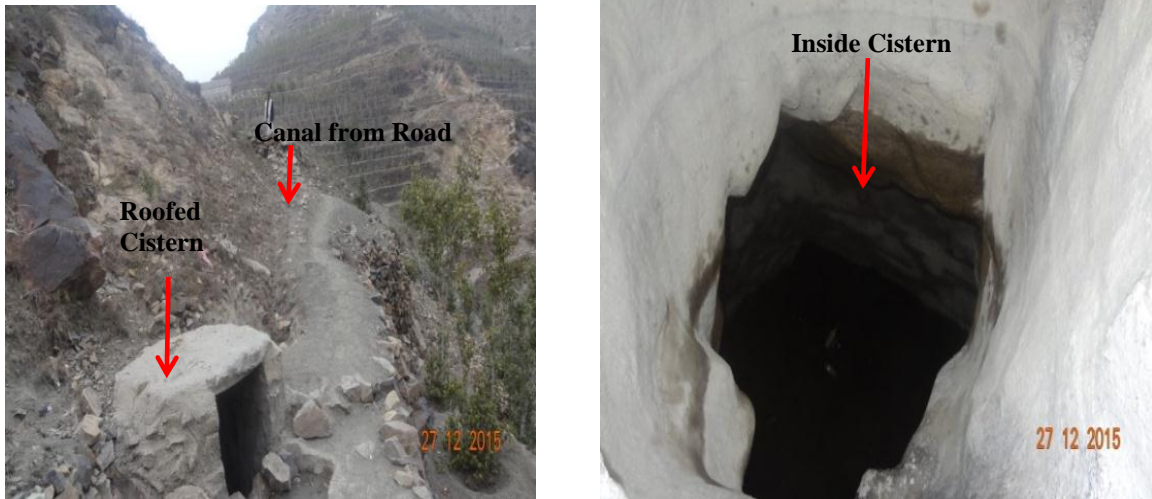

**Figure 23 Roofed Dug Cistern near the main road**



**Figure 24 Earth humps to divert the surface runoff to the farms**



**Figure 25 Right: Earth check steps to divert the surface runoff to the tank by earth hump, Left: Open water harvesting tank and an earth hump**

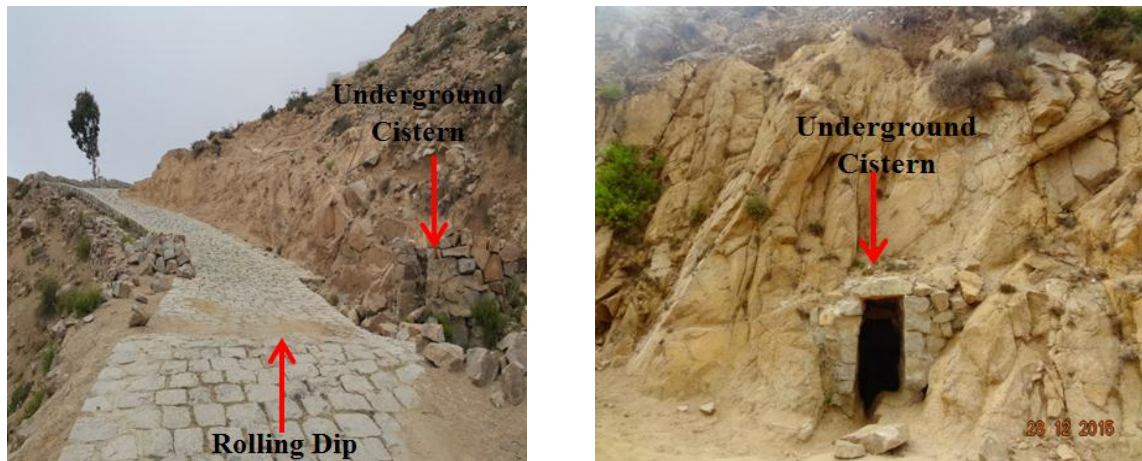

**Figure 26 Underground digged cistern at the inner edge of the stone paved road**

There are a lot of water harvesting techniques which already used for harvest water from the road by different methods such as:

1. Harvesting from road surface: use the road surface as main catchment channel to collect and divert water to the purposed location by using the (inward slope) of the cross section or the rolling dips and humps.
2. Rolling Dips: there are a lot of stone paved rolling dips or earth rolling dips (humps) which built using sand and dry stone check walls to divert and collect road surface water to the proposed store or use locations.

3. Channels: there are dry stone channels to transport the surface water from rolling dips and spillways to the proposed location, these are longitudinal channels parallel to the road alignment. Figures (27 to 30) show some water diverting techniques along the sub-road.



Figure 27 Rainwater diverting earthen humps and earthen channel

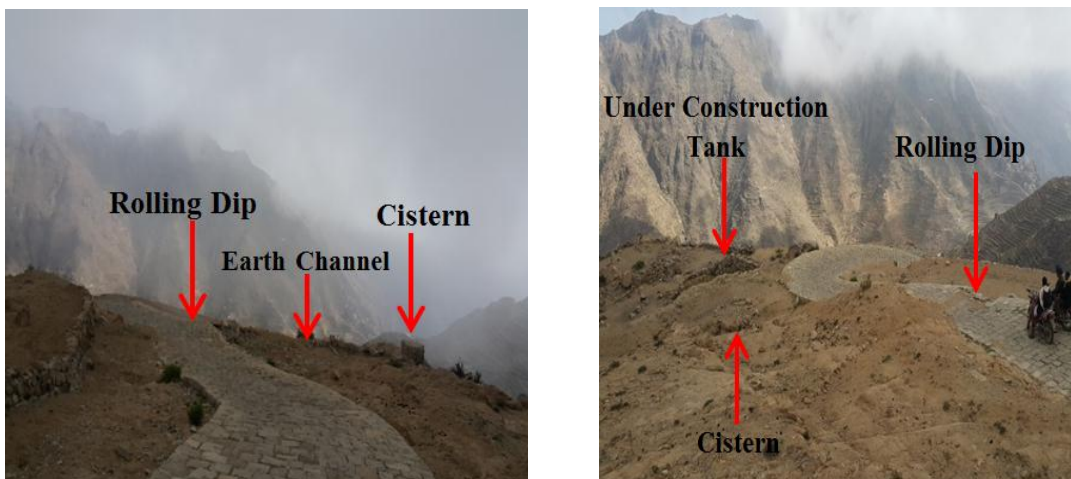

Figure 28 Stone paved rolling dip to divert rainwater to the tanks

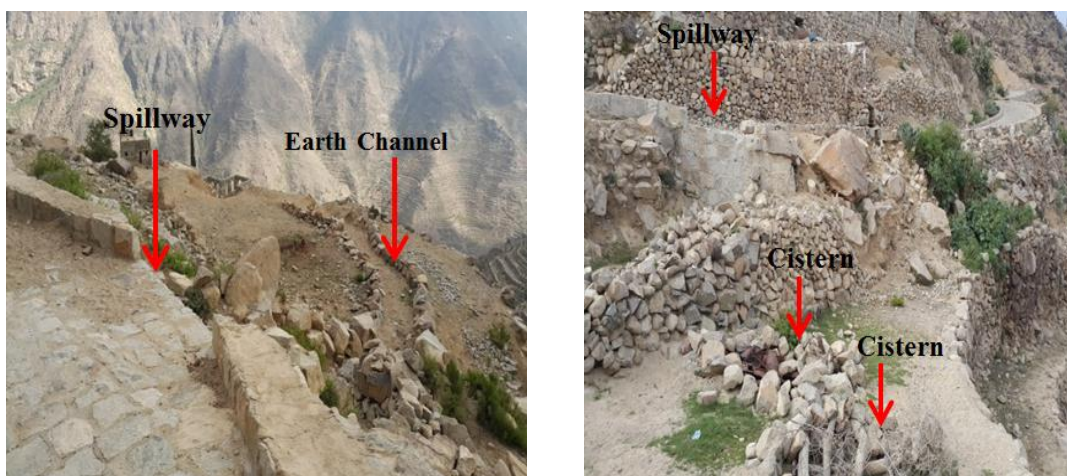

Figure 29 Earthen channel after the spillway to divert the water to the cisterns





Figure 30 Longitudinal parallel channel

#### ***4.1.2 Stakeholders questionnaire results and analysis***

The SPSS and Excel software program had been used to analyze the collected data from field (the questionnaires filled along the road sections).

##### ***4.1.2.1. Water Resource***

Almost all the sample rely on rainwater as main source of water, in adjacent with other sources. The multiple response of the farmer's questionnaires was 41 out of 22 samples cases. The results from field data questionnaires analysis have designated that the available water resource are: 53.7% from rain; 4.9% from local water supply network; 24.4% depend on wells; 7.3% buy water trucks; 7.3% collect water from springs and 2.4% from fog harvesting. Figure (31) shows the results of data analysis for water resource in the study area.

For the water supply network either the network is out of services (from Manakah) or under study phase. The wells depth varies between 4 to 25 m and the production of the wells vary from 80 liter, 1000 liter and 2000 liter per day

For the price of water trucks either from Al-Haimah, the 13 barrels price is 12,000 Y.R. ( $1 \text{ m}^3$  cost approximately 4600 Y.R), or from Khamees Bani Sa'ad, the 15 barrels price is 10,000Y.R ( $1 \text{ m}^3$  cost approximately 3333 Y.R)

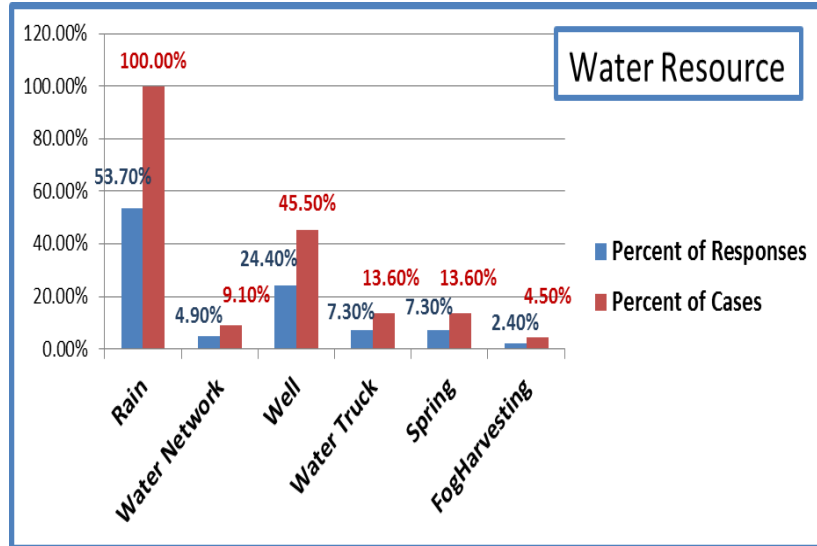

Figure 31 Data analysis of water resource in the study area

#### 4.1.2.2. Water Scarcity Issues and Adaptation

The farmers raise their concerns of water scarcity as clarified from the samples where 95% of the farmers face water scarcity, while 5% don't face water scarcity. Figure (32) shows data analysis of water scarcity issues.

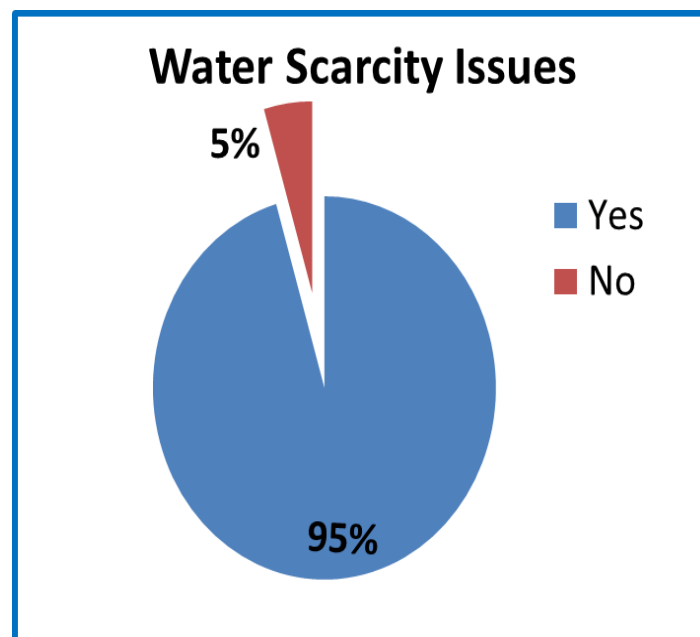

Figure 32 Data analysis of water scarcity issues

The farmers used to face the water scarcity by using different adaptation measures as follows: 32% of the farmers bring water from the water sources, 23% harvest rainwater, 14% purchase water trucks and harvest rainwater from roofs, 14% rationalize water use & avoid extravagance or share spring water turns or purchase water trucks, 9% rainwater & fog harvesting and water saving, 4% hand wells, and 4% immigrate from their village to another internal place. That means all the above measures are adapted to cope with the water scarcity issues in the study area. Figure (33) shows data analysis of water scarcity adaptation.

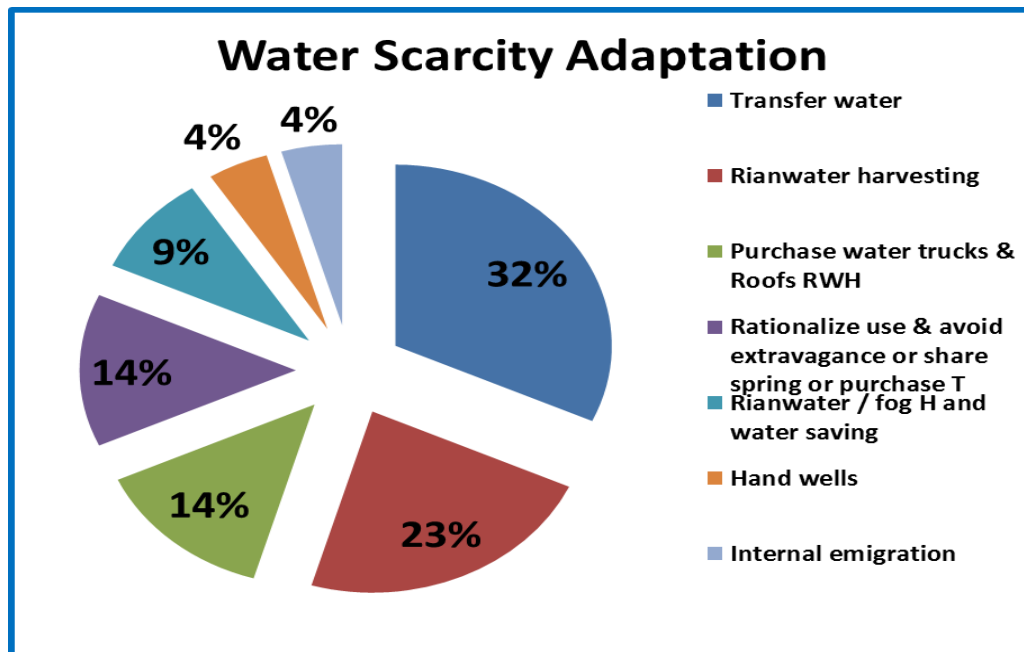

Figure 33 Data analysis of scarcity adaptation

#### 4.1.2.3. Climate change risks and rain season change

The farmers face climate change risks as explained from the samples as 27% of the farmers face water scarcity; 36% face drought and lack of agriculture & pasture; 23% their income were reduced; while 14% don't face any risks due to climate change. Figure (34) shows data analysis of climate change risks.

The change of rain season from farmer's point of view 86% said there are lack of rain while 14% said the rain season delayed. Figure (35) shows data analysis of rain season change.

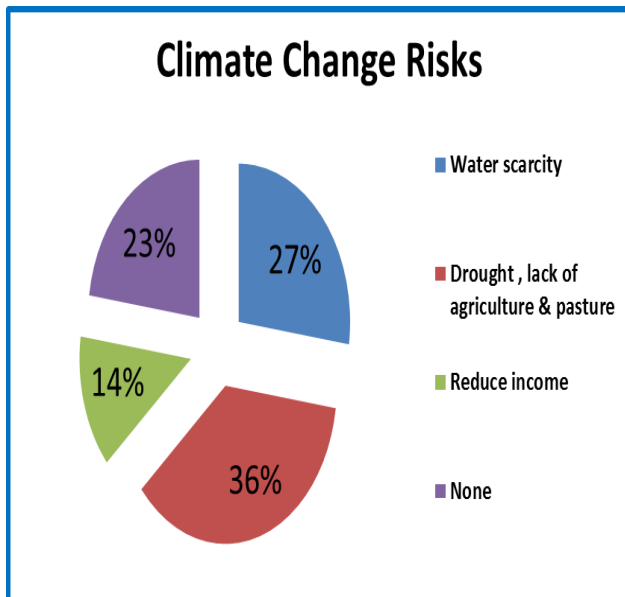

Figure 34 Climate change risks

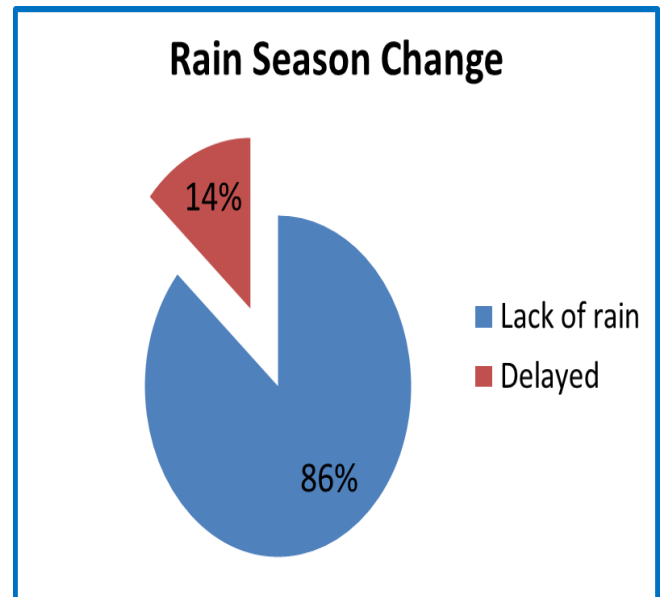

Figure 35 Rain season change

#### 4.1.2.4. Roads & Water Harvesting

##### a. Land ownership nearby road and running floods water use

The land ownership adjacent to the road side indicate that about 91 % of the sample are farmers whom have lands adjacent to the road side and use the floods water running from road to irrigate their farms and 9 % of the sample farmers don't use the floods water running from road and don't have lands adjacent to the road. Figures (36 & 37) show data analysis of land ownership near the road & running roads floods use.

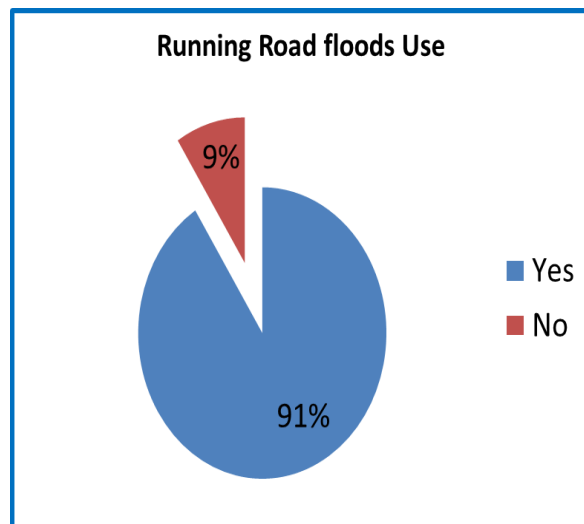
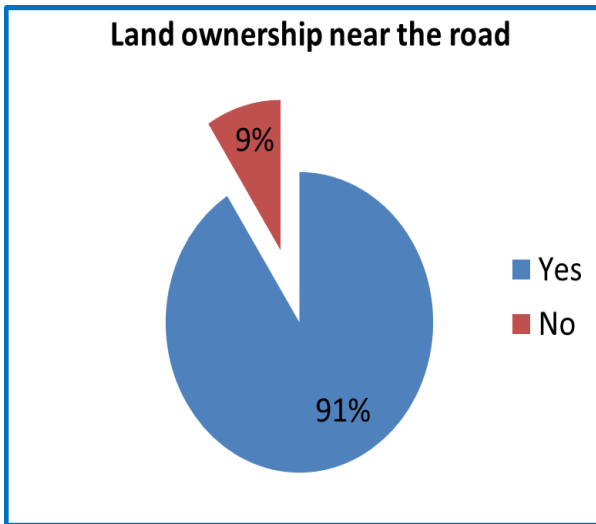

Figure 36 Data analysis of land ownership

Figure 37 Data analysis of running floods use

b. Road rainwater harvesting techniques

The multiple responses of the farmer's questionnaires were 33 out of 22 samples cases. The questionnaires have indicated that farmers used to harvest the floods water running from road surface and road structures by using different techniques where: 57.6% are using humps across the road; 15% harvest RW from channels; 9.1% use side ditches to harvest RW; 3% use (culverts; spillways; terraces and WH structures), while 6.1% don't use any techniques. That means all the above techniques are used to harvest rainwater from road. Figure (38) shows the analysis of road rainwater harvesting techniques.

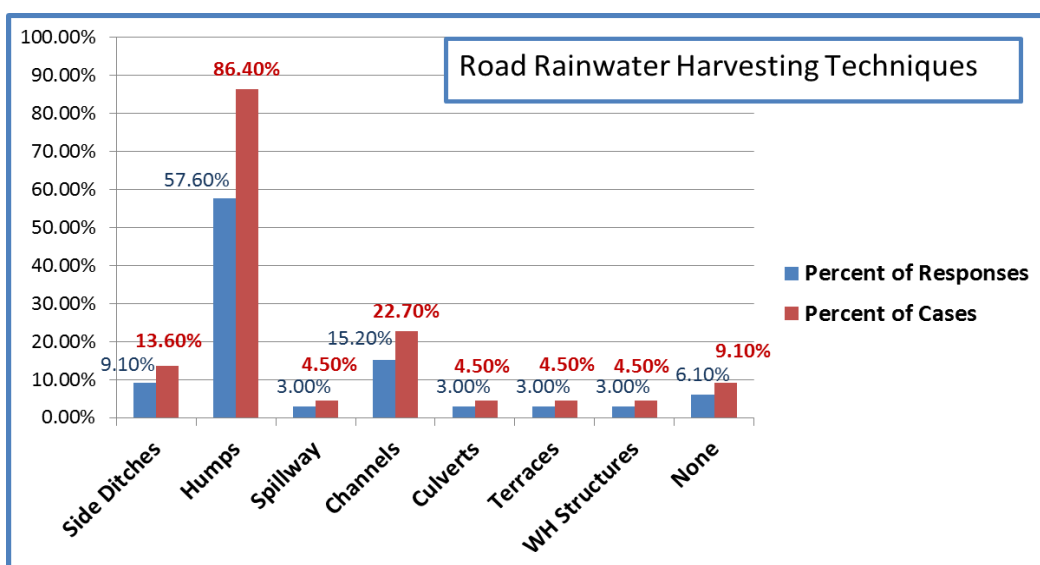

Figure 38 Data analysis of road rainwater harvesting techniques

#### 4.1.2.5. Data analysis of water rights

All farmers consider rainwater running on the road their right. From their point of view about why they consider rainwater running on the road their right, about 59% of them said it is a well-known right, 18% said it is property and well known water ways (in Maraheg), 18% said water streams ways remain as they were, and 5% said it is father and grandfather Manhal for water. Figure (39) shows the analysis of the reason of water rights from roads. Some farmers claimed that water channels were abandoned after the road excavation and the road profile were not appropriate to divert water and they used humps and pumps to transfer the water to the tank.

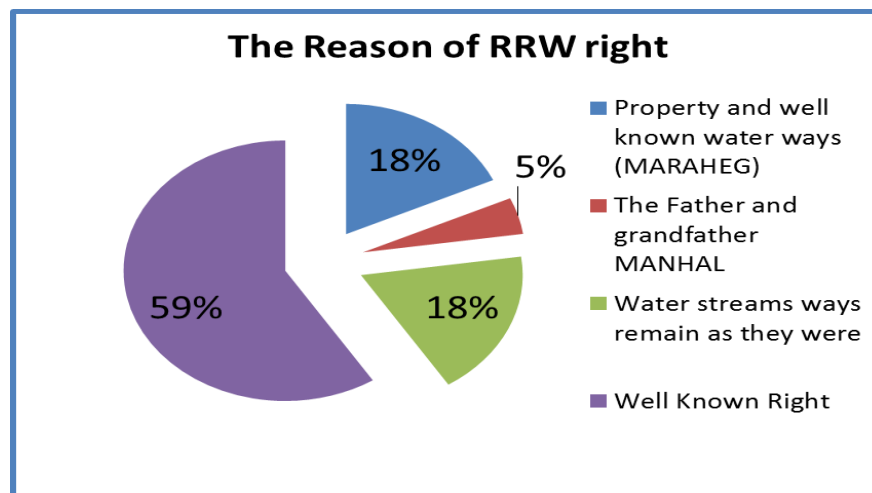

Figure 39 Data analysis of water rights from roads

#### 4.1.2.6. Usage & Benefits of RRWH

##### a. Roads rainwater harvesting usage

The multiple response of the farmers questionnaires were 61 out of 22 samples cases. The questionnaires showed that farmers are using the harvested water running from road surface and road structures for different proposes as follows: 14.8% for drinking; 31.1% for agriculture; 26.2% for domestic & livestock and 23% for supplementary irrigation; while 4.9% don't use it. Figure (40) shows data analysis of RRWH usage.

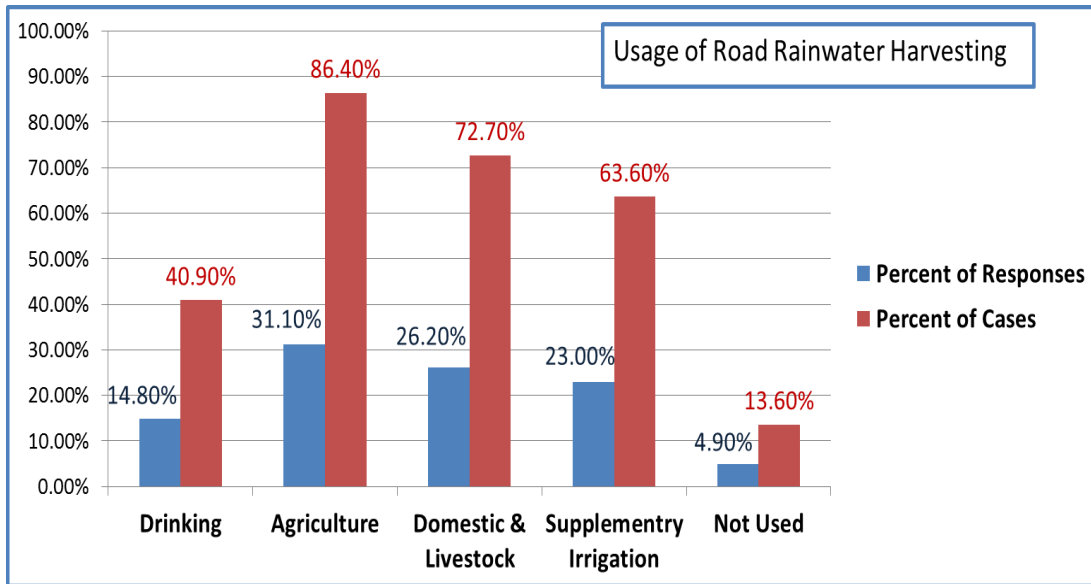

Figure 40 Data analysis for RRWH usage

b. Benefits from harvested rainwater from road

The multiple response of the farmers questionnaires were 48 out of 21 samples cases. The questionnaires indicated that the benefits of harvested road rainwater are as follows: 43.80% water saving; 35.40% increase production, 8.30% reduce buying water; 6.20% supplementary irrigation and 6.20% had other views such as cover needs in dry seasons.

Figure (41) shows the data analysis of RRWH benefits.

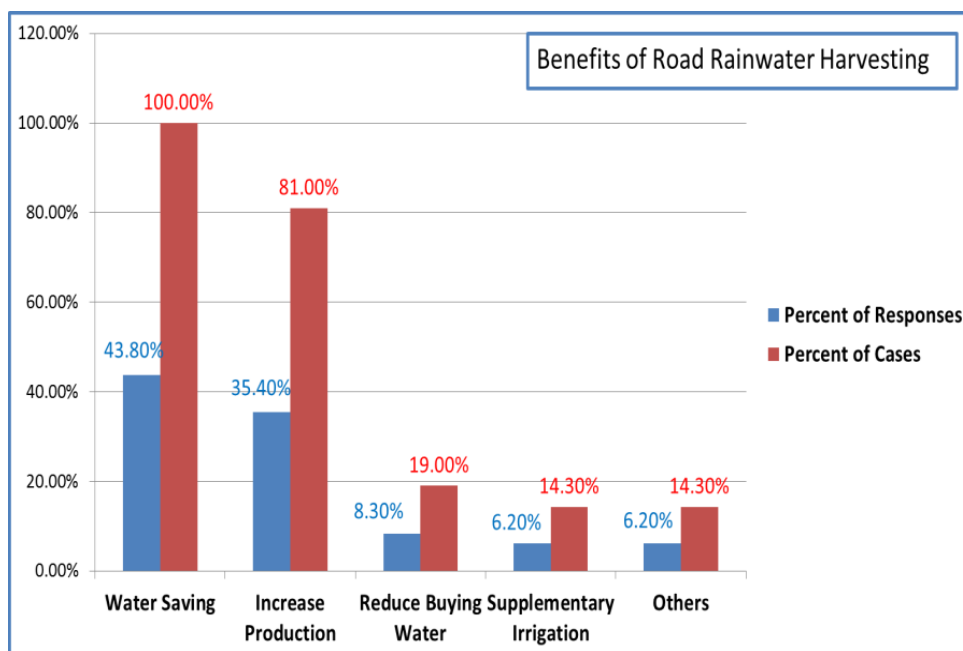

Figure 41 Data analysis of benefits of RRWH

#### 4.1.2.7. *The effect of road construction on water way patterns*

The results of the data analysis showed that about 59% thinks that the road changed the water way patterns, while 41% thinks that the water way patterns are not changed by the road. Figure (42) shows the data analysis of the effect of road construction on water way patterns.

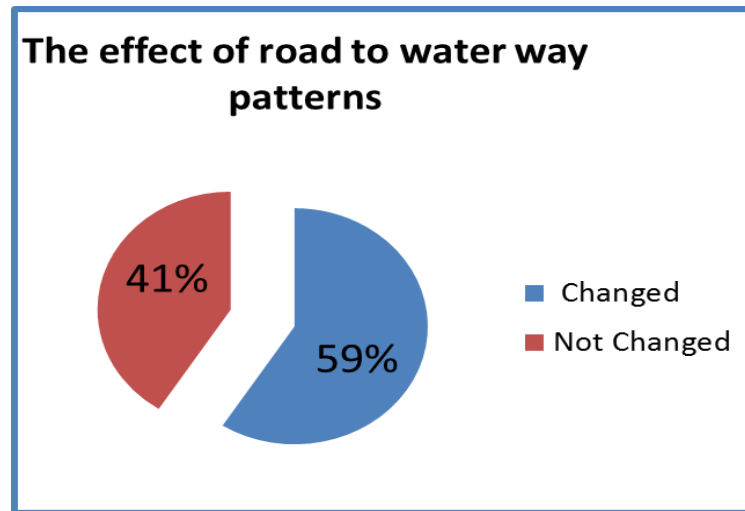

Figure 42 Data analysis of the effect of road to water way patterns

#### 4.1.2.8. *Main problems prevent flood water delivery to farms and solution:*

From the results about 55% think that there are no problems, while 36 % thinks that the problems are water blockage by road excavation debris and huge floods, and 9% thinks that the problem is road construction as the road design level is below the farmland. Figure (43) shows data analysis of problems prevents flood water delivery to farms..

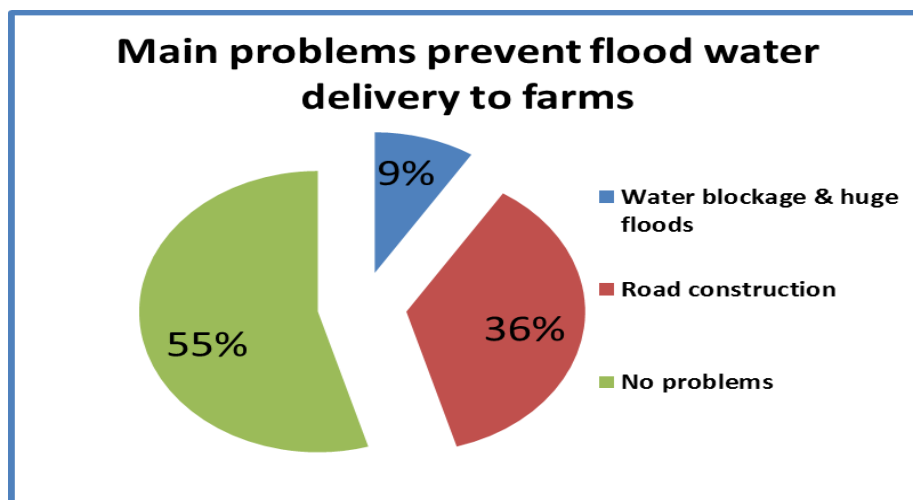
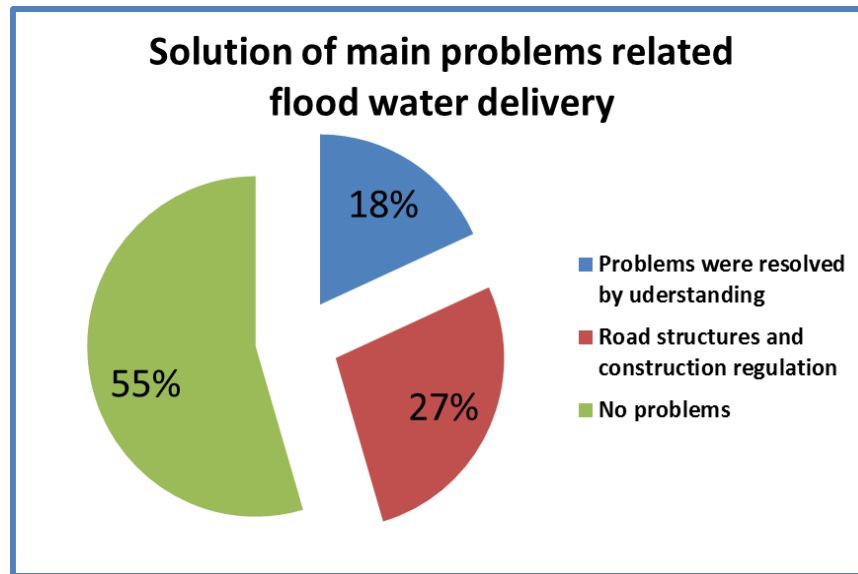

Figure 43 Data analysis of problems prevent flood water delivery to farms



While, about 27 % of the inhabitants showed that the problems were resolved by understanding the potential conflicts, and 18% thinks that road structures and construction regulation will solve the problems especially the issue of dynamite using in excavation and cut sections, while the rest have no problems to be solved. Figure (44) shows data analysis of solution of main problems related flood water delivery.



**Figure 44** Data analysis of solution of problems prevent flood water delivery to farms

#### ***4.1.2.9. Roads water damages & mitigation***

The results of data analysis showed that about 64% claimed that roads floods cause damages to the surrounding landscape and farmlands are ruined and buried; 9% said that road floods disturb and damaged water ways; 14% raised concerns about the erosion effect along the road; 4% fair about the transmit of sediments, erosion and flood accumulation and 9% don't face any damages. Figure (45) shows data analysis of damage caused by water from roads.

Based on the questionnaire and from farmer's point of view about the mitigation of damages they suggested the following mitigation measures: use spillways, humps, channels, ponds, sedimentation checks, check walls in water streams, water retention, diversion structures near roads, and check dams to collect water. Others think that the

contractor excavation debris must haulage the allocated locations and contractor should maintain water channels and old water ways. While some of them think that maintenance for agricultural terraces should be conducted by farmer's, as well as paving road by stones and protection works may prevent erosion.

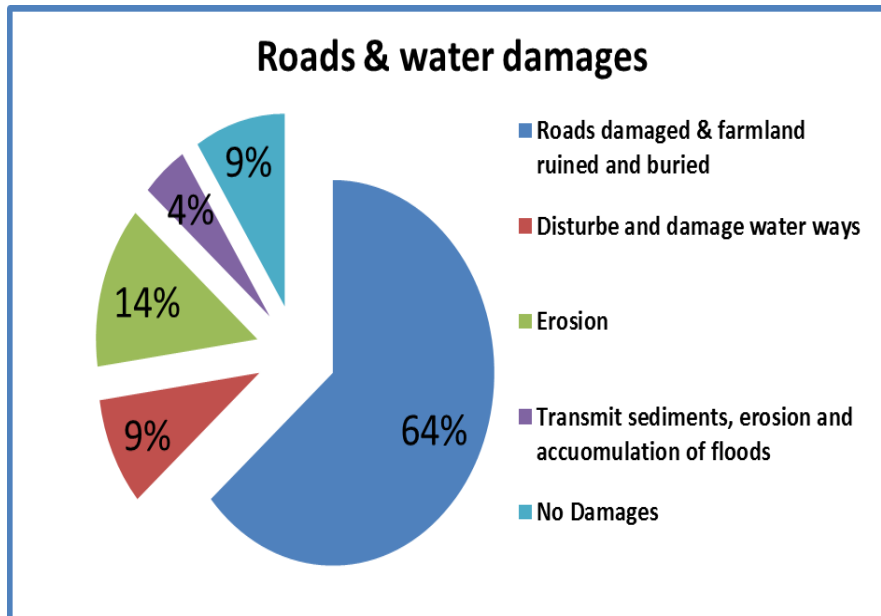

Figure 45 Data analysis of the damage caused by water from road

#### 4.1.2.10. RRW Contamination, source, solution and purify techniques

The results indicated that 50% think that the water from road is contaminated and 50% think that the water from road is not contaminated. Figure (46) shows data analysis of RRW contamination.

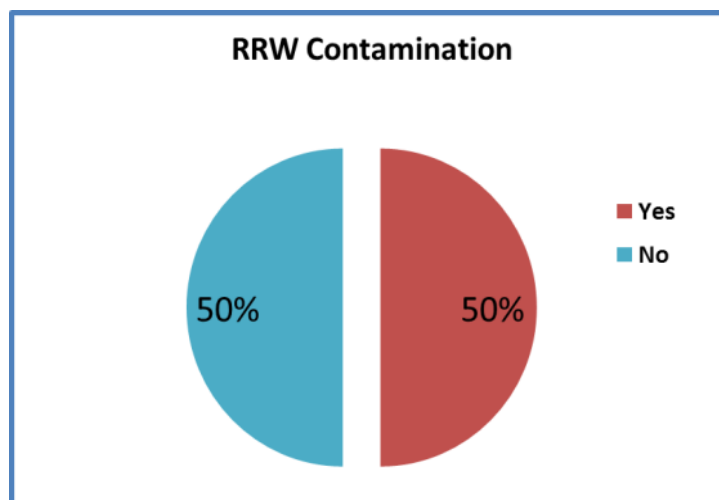

Figure 46 Data analysis of RRW Contamination

a- Contamination source: the results indicated that the contamination of harvested water from road surface is due to clay, those represent 32 %, while 9% think the contamination is from animal waste, and 9% think the contamination is from clay, animal waste and tires residues. Figure (47) shows data analysis of contamination source.

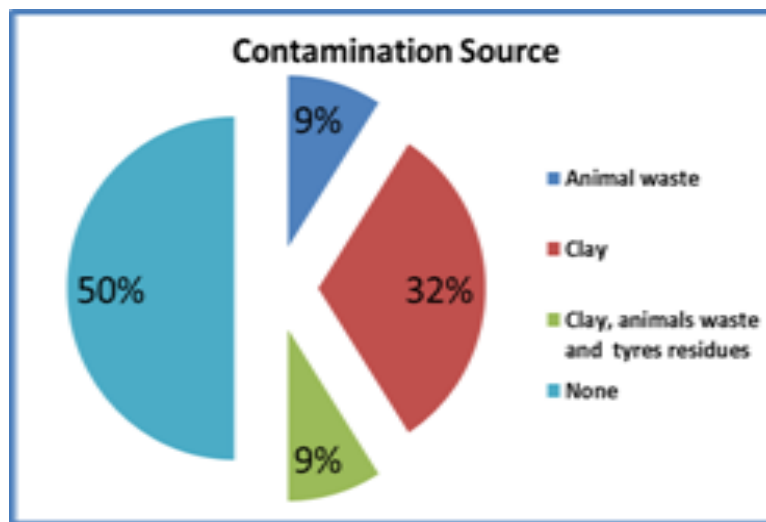

Figure 47 Data analysis of Contamination source

b- Solution of contamination: the results indicated that about 86% think that there is no solution as the harvested water were used in agriculture, while 9 % suggested using filters and 5% suggest using sedimentation basins. Figure (48) shows the data analysis results of contamination solution.

c- Purify techniques: the results clarify that about 64% don't use any purification techniques, while 14 % using silver filters, 9% using metal filters, 5% using sedimentation basins, 4% using sand filters, and 4 % using chlorine and filters. Figure (49) shows data analysis of purifies techniques.

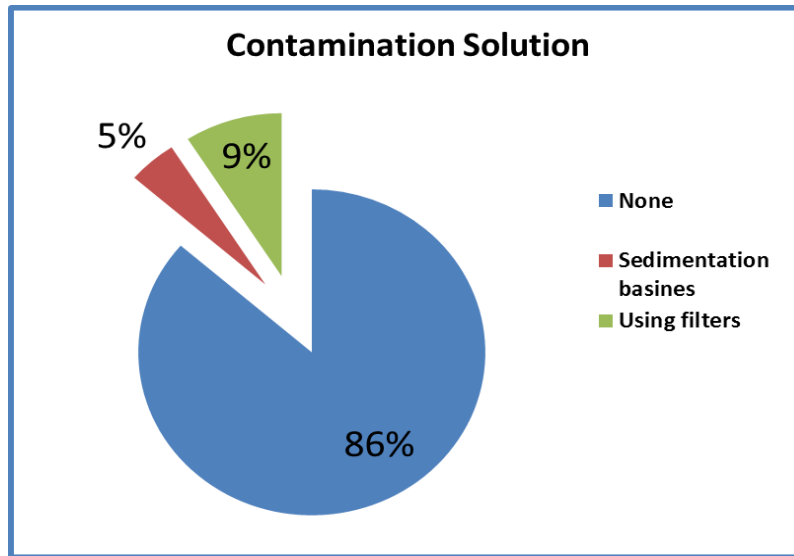

Figure 48 Data analysis of Contamination solution

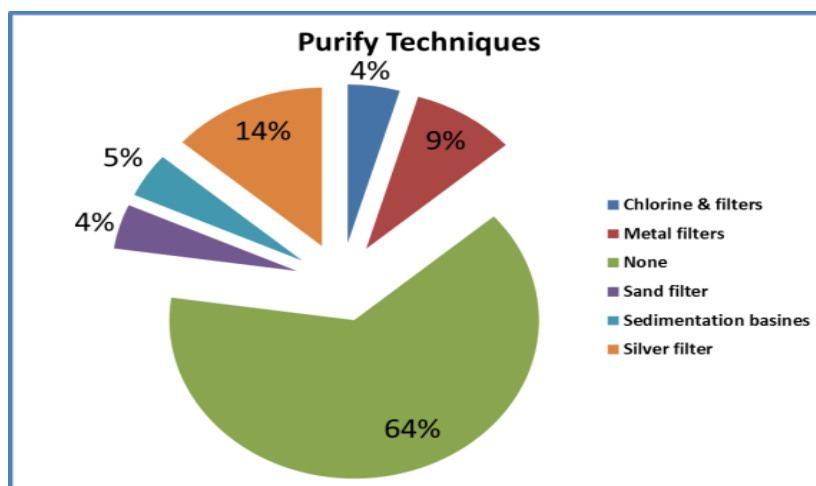

Figure 49 Data analysis of purify techniques

#### ***4.1.2.11. Women Rule in Water Resource and Rainwater Harvesting***

Almost all the sample thinks that RRWH will help women in agriculture and households works. From farmer's point of view on the rule of women in water resource and rainwater harvesting. 77% of them said that women bring the water from the water sources to the house, 14% said that women bring the water from the water sources to the house and harvest rainwater from roofs, and 9 % said that women bring water from the source to the house and divert flood water in the absence of the man & believe that

woman is beside the man under rain and sun. Figure (50) shows data analysis results of women role in water resource and rainwater harvesting.

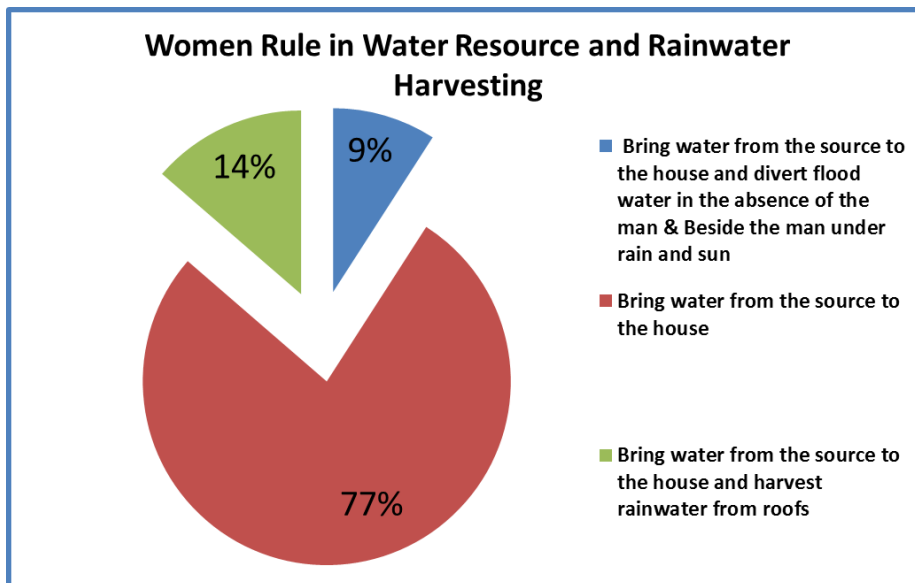

Figure 50 Data analysis of women rule in water resource and rainwater harvesting

#### 4.1.2.12. Farmers recommendation and future ambition for RRWH

- Construct and support check dams to recharge surface wells
- Maintain agricultural terraces on both sides of the road and in floods ways.
- Complete the road and construct side channels, culverts and humps to harvest water and to divert water to the coffee farms or construct water harvesting tanks at the culverts outlets.
- Construct large tanks, underground tanks and ponds for water harvesting and to grow coffee trees for the area and support agriculture
- Digging new water wells, install water pipe network and don't waste the road running floods.
- Raise awareness for the importance of agriculture and water harvesting.

## ***4.2 Road engineers questionnaire results and analysis***

A structured questionnaire was distributed among 45 random road engineers in MPWH, RMF, GCRB, and RAP that filled by them to find out the general methods used for water related structures designs in roads, and to measure their awareness of water harvesting aspects from roads. Also the Excel program and SPSS had been used to analyze these data. Example of the results of questionnaires analysis is presented in Annex 6.

The results from the engineers questionnaire are different and vary from engineer to engineer. As there are a number of multiple closed choices with the possibility to add other views to the closed choices. The multi response analysis tool was used to calculate the statistical of responses frequency for each individual choice, and the other views were listed separately. This clarify the two percentage of the bar chart and the responses percent were used in result analysis in multiple choices questions.

### ***4.2.1. Road Engineers awareness on water harvesting from roads***

The results indicated that about 58% of the engineers have experience about the effect of roads on water harvesting, while 42% of them do not have any experiences in this field. Figure (51) shows data analysis of engineers experience about the effect of RRWH.

Several results were extracted from the engineer's questionnaires about the impact of roads on water harvesting as follows:

- The roads construction may affect the mechanism of natural water ways, drainage pattern, springs, water collection basins, distributing water for agriculture lands. Also the road construction affects the concentration of the water in culverts, divert water from road by ditches or side drain, where some locals use skew earth humps

or agricultural pipes to divert road rainwater to their farms while in some cases a culvert is installed to divert the water to the farms if requested by farmers.

- All this will be achieved after conducting hydrological study; define the road catchment area; define the collection method and storage or distribution technique for different uses such as: recharge, drinking, agriculture, irrigation and domestic use. Therefore, the road is maintained and the farmers benefited.
- The roads protection works which mainly focus on protecting roads from floods, can be adapted to serve community, control water and recharge by coordination with agencies and considering the total cost of the project and the landscape of the area.

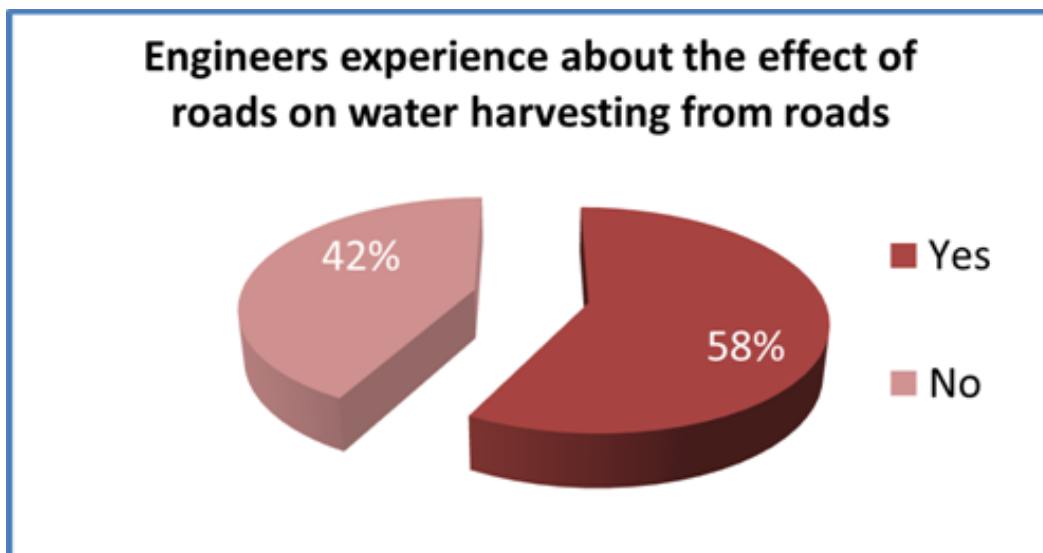

**Figure 51 Data analysis of engineers experience about the effect of RRWH**

- The roads may have positively impact on water harvesting as it increases the availability of water.
- The gateways are suggested to control water in bridges and large culverts, in order to maximize the benefit from the floods water running in the wadis crossing the roads.

- In rural areas rainwater harvesting is very important for locals and they collect it in earth ponds (KAREEF), ponds and tanks in open areas and at the villages scale for agriculture land irrigation and domestic use but the quantities is low.
- Construct WH structures in water gathering location from road drainage structures and culverts distribution along the road for the purpose of water drainage distribution for the purposed areas.
- No clear effect due to the mountainous characteristic of Yemen and the discharge drain according to natural land slope.

#### ***4.2.1.1 Groundwater recharges from roads***

From results about 69% of the engineers said it is possible to use roads to collect water for groundwater recharge, while 31% of the engineers said it is not possible to do that. Figure (52) shows the results of data analysis of engineers experience about groundwater recharge from roads.

Those whom answered yes, described the possibility to use roads for groundwater recharge as follows:

The runoff from road culverts, ditches, roadsides, channels and road catchment could be diverted, directed and collected to appropriate locations. These locations would be: open recharge areas, earth ponds, recharge wells, recharge dams specially in flat areas and check dams at the end of the ditches may be used). This practice can contribute to groundwater recharge and water retention. Others said that, roads will act as surface recharge structure when the body of road act as water dam with the use of the asphalt surface as spillway. Finally, the engineers recommend that groundwater recharge from roads should be considered in the BOQ as an item (build masonry walls, protection works or dams in wadis), which may add additional cost to road projects. And a strategic planning should be reflected by coordinating with related agencies.



Those whom answered no, said no consideration were taken to use roads for groundwater recharge and others said that dams were used for groundwater recharge.

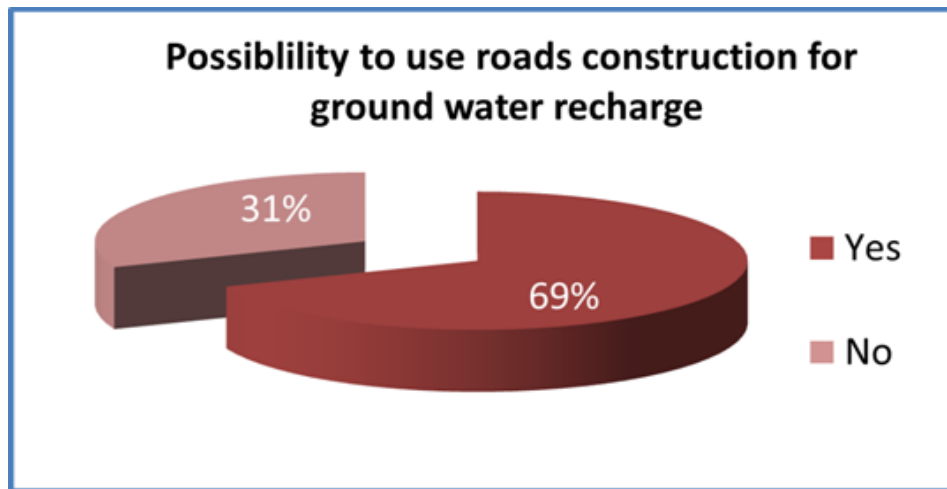

Figure 52 Data analysis of groundwater recharge from road as Eng. Point of view

#### *4.2.1.2 Water harvesting for irrigation or groundwater recharge from the culvert*

The result indicate that only 22 % considered water harvesting for irrigation or groundwater recharge from the culvert outlet by coordination and strategic cooperation between agencies which consider project cost and channels used to divert water from culverts outlets to areas of groundwater recharge basins or construct small dams at the culverts outlets, also particular design of culverts wings was used to direct the flow if requested by farmers. Moreover, the type of soil play a rule in groundwater recharge. While, the rest 78% of engineers don't consider water harvesting from culverts due to the following reasons: not recognized; it need high cost and social & environmental study to serve the stakeholders ; where only road protection were considered; except self-initiative from farmers; It is not taking in designs; and the insufficient use of this water which discharged away from the road without taking consideration to take advantage of this water which sometimes cause erosion in farmers lands near the outlets of drainage structures. Others suggest the following: construct deep water ponds at culverts inlets to collect water and make use of it in the areas that suffer from water

shortage, and they also suggest that water harvesting must be taken in consideration and defined water ways to facilitate water collection. Figure (53) shows data analysis of engineers point of view about consideration of water utilization from culverts.

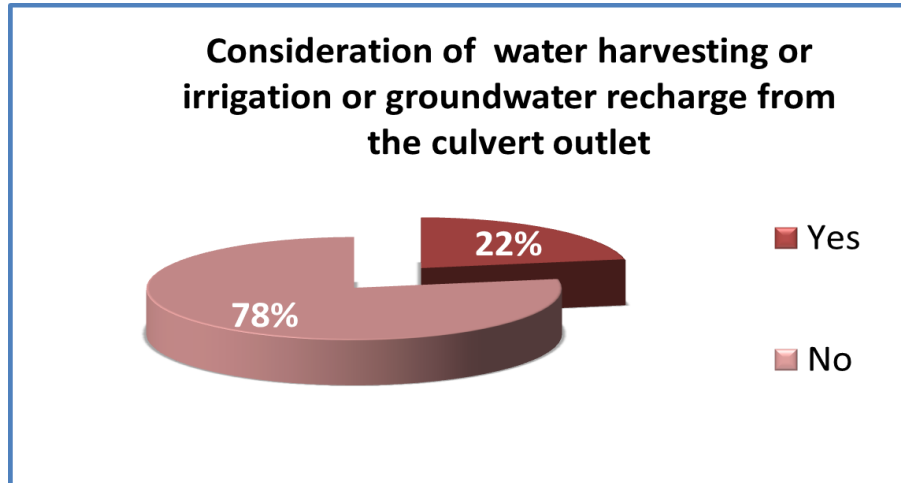

Figure 53 Data analysis of considerations of water utilizations from culvert as Eng. view

#### ***4.2.1.3 Water harvesting for irrigation or groundwater recharge from road side drainage structures***

From the results only 29 % considered water harvesting for irrigation or groundwater recharge from road side drainage structures by the following measures: (1) coordination with agencies and conduct the feasibility study of the project. (2) in some international project which prepare integrated hydrological study. (3) in some places channels were constructed at the end of side drainage to direct the discharge to the purpose location (pond or tank) for the beneficiary use. (4) keep the path of water way for the adjacent land. (5) sometimes if people request to install smaller diameter steel or concrete pipes to direct water from the inner side ditch to the farms. While 71% don't consider water harvesting for irrigation or groundwater recharge from road side drainage structures. They referred that for having no idea about this issue, and they noticed that the only practice is self-initiative from people to irrigate their farms or store the harvested water in ponds. Figure (54) shows data analysis from engineers point of view about consideration of water utilization from road side ditches.

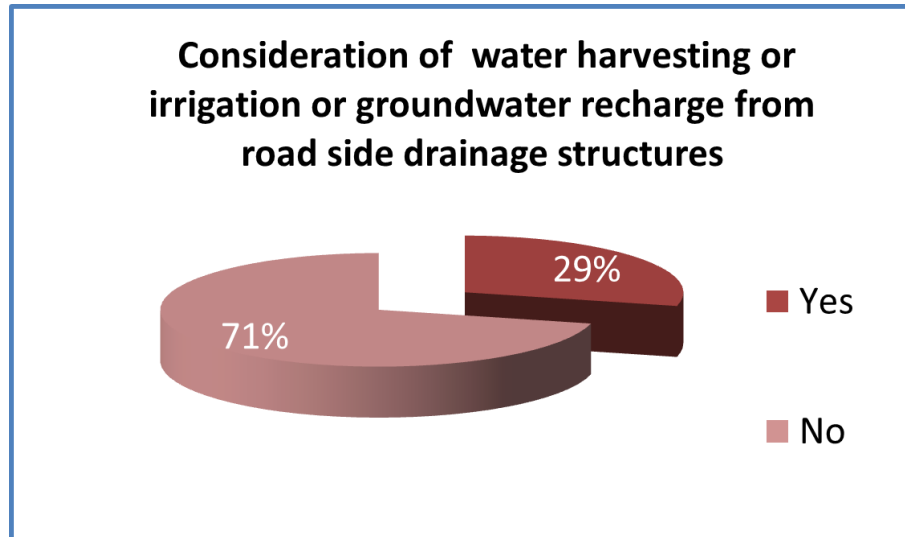

Figure 54 Data analysis of consideration the water utilizations from road side as Eng. view

## 4.2.2. Current culvert design understanding

### 4.2.2.1 Location of culverts in road projects

The multiple response of the questionnaires were 96 out of 45 samples cases. Figure (55) shows data analysis results for defining the location of culverts in roads projects. The results have indicated that the culvert location is defined as : about 36.5 % said due to the location of water ways and streams crossing the road, 32.3% said according to details hydrologic study, 14.6 % said at each vertical sag curve, 3.1% said at equal intervals, and 13.5% had other views about the culvert location defining.

Those who add others indicator to their views were as follows: (1) Beneficiary participation (the elderly) by inquiring about the size and height of the water in the wadi and how much the higher level reached and design engineer opinion, (2) land survey for natural stream and calculate the catchment area, (3) the distance between the culverts should not exceed 700 m, (4) the location is defined when there is need to transform water from side to side and in multi curves sections to alleviate the accumulated water from the ditches, (5) the location is obligated in some agricultural land due to social

water rights issues, (6) in places of water gathering on the surface of the road, and (7) in international projects according to detailed hydrologic study.

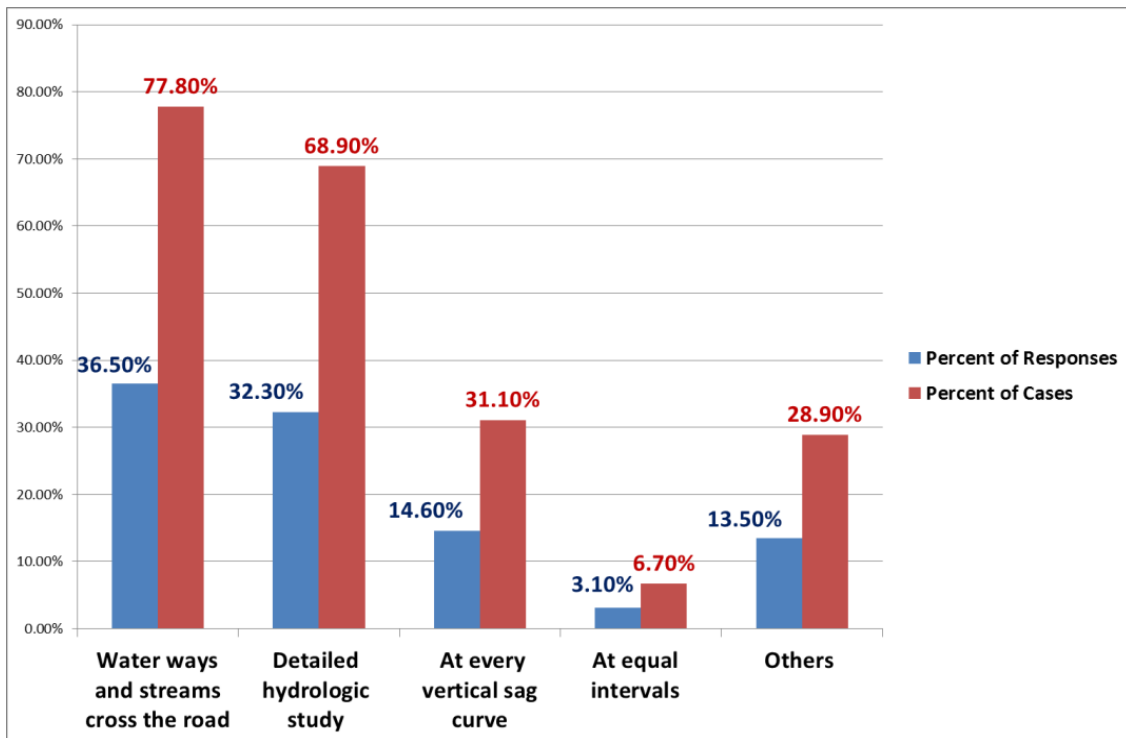

Figure 55 Location of culverts in road projects

#### 4.2.2.2 The culverts type selection in road projects

The multiple response of the questionnaires were 90 out of 45 samples cases. Figure (56) shows data analysis results of culverts type selection in roads projects. The results observed have specified that: 17.8 % use technical standards; 24.4 % use detailed hydrologic study; 30% use the typical designs from MPWH & the experience of the consultant; while 12.2% consider the cost analysis alternative for the available materials in the project location, and 15.6% had other views.

Those whom add others indicator to their views are as the following: nature of the region/site, social factors, hydraulic study, consultant engineer experience, culvert dimensions, budget availability and maintenance consideration.

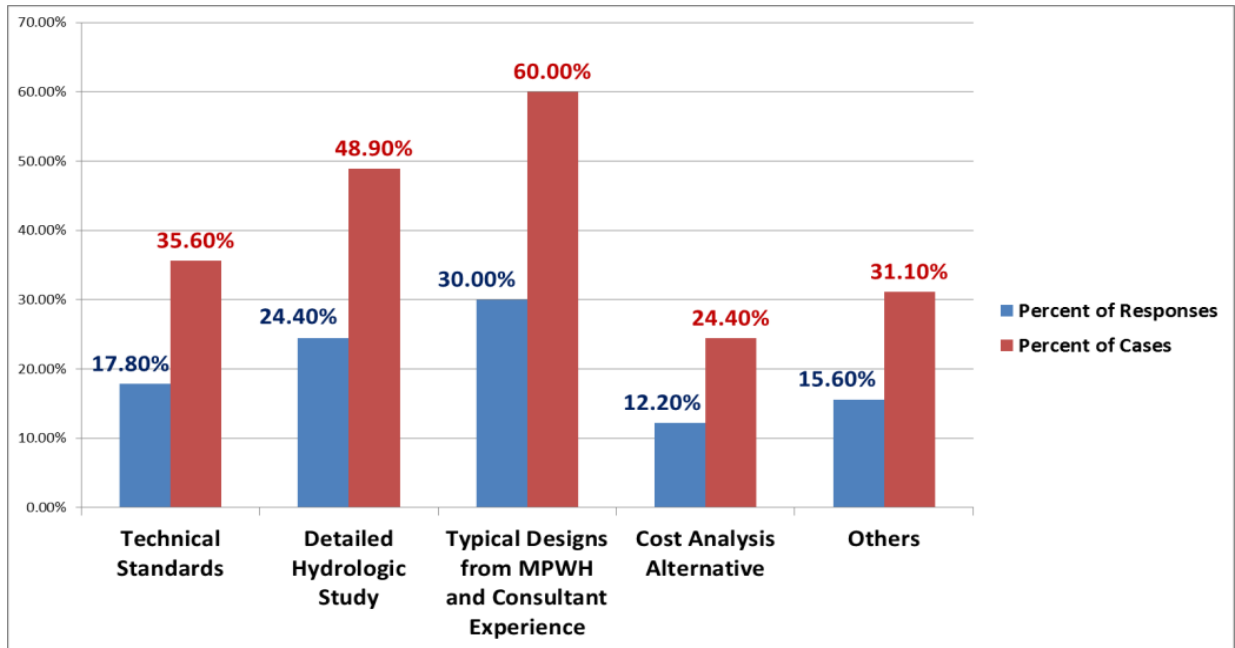

Figure 56 culverts type selection in road projects

#### 4.2.2.3 The size of culverts design in road projects

The multiple response of the questionnaires were 65 out of 45 samples cases. Figure (57) shows data analysis results of culverts size design in roads projects. The questionnaires results have designated that the size of the culvert is designed according to: 38.5% detailed hydrological study; 41.5% the available width and height of the stream line; and 20% add other views. Those whom had different views add the following: (1) according to experience, (2) the hydrologic & hydraulic study should consider the consistency of natural stream dimensions. (3) the hydrologic & hydraulic study only considered in the strategic/international projects. (4) some of them estimate the catchment and the available width & height of the stream line. (5) by asking elders in the project area.

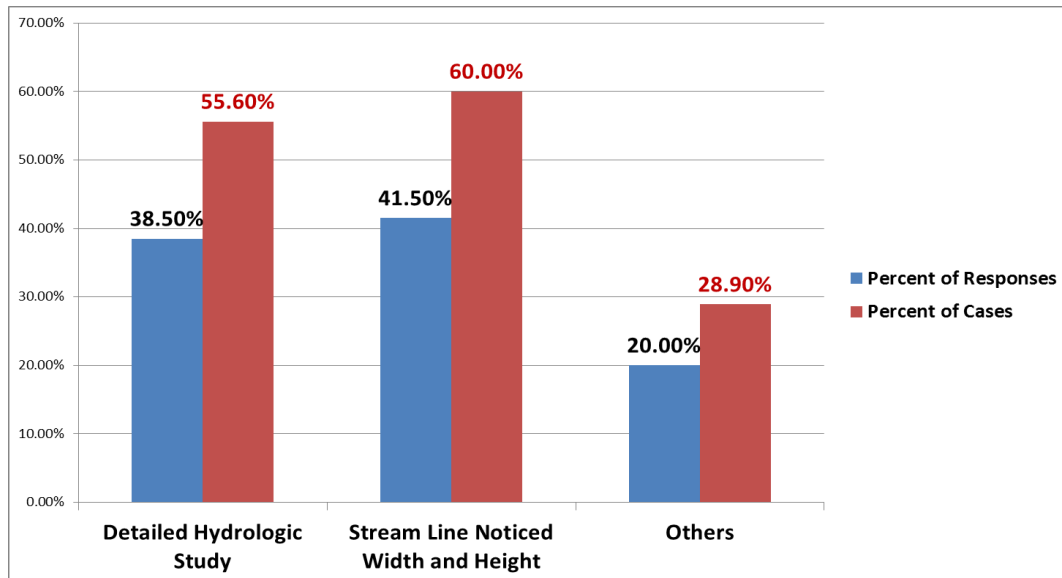

Figure 57 The size of culverts design in road projects

#### 4.2.2.4 Culvert Inlets Design

The multiple response of the questionnaires were 70 out of 45 samples cases. Figure (58) shows data analysis results of culverts inlet design. According to the questionnaires results: about 45.7% said due to typical drawings and the inlet type in cut or fill section; 32.9% said onsite structural designs as needed; 18.6% said detailed hydrological study; 2.9% have other views such as: typical drawings approved by the MPWH for all projects, function of retained embankment, structure skew and overflow requirement, and no designs for the inlets as there is no real design for the culverts.

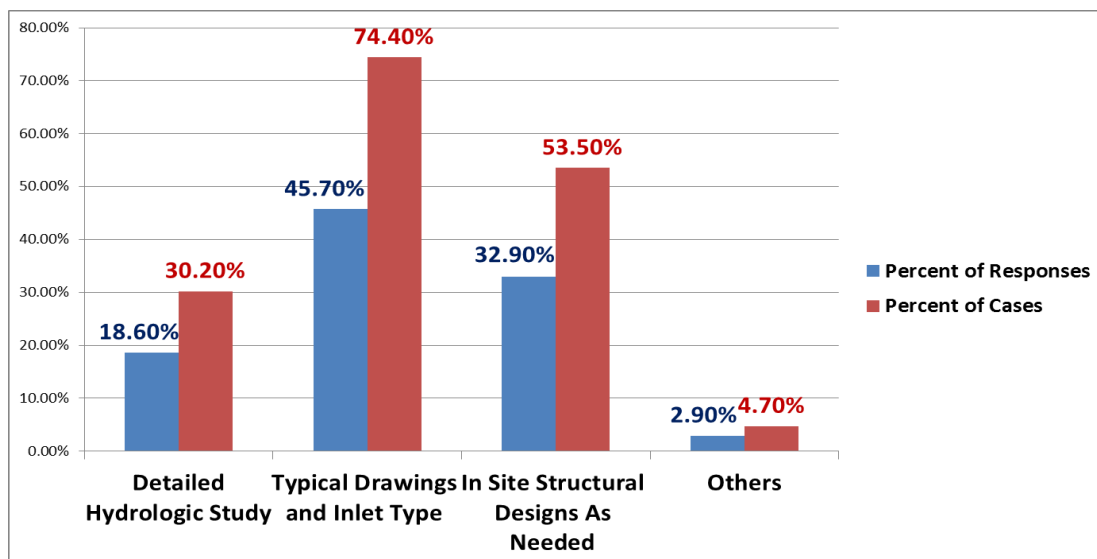
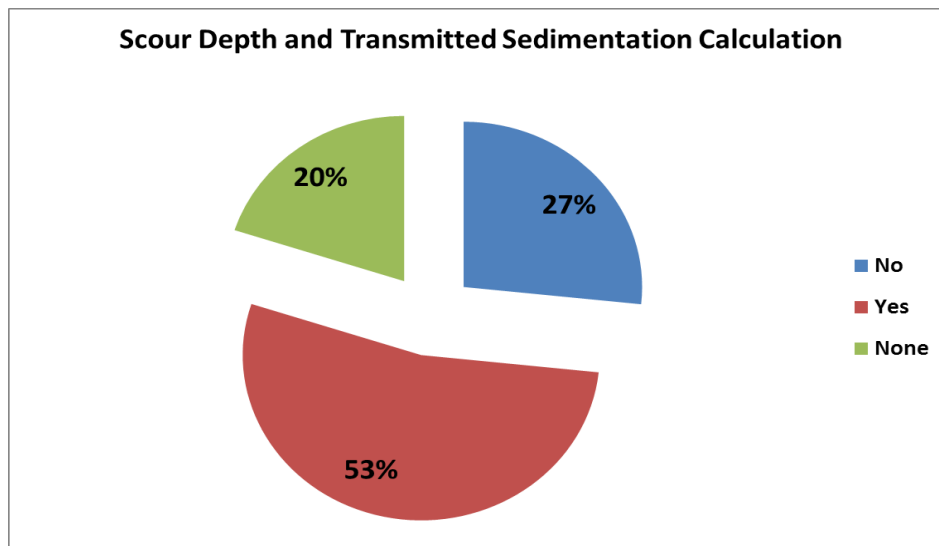

Figure 58 Culvert Inlets Design

#### 4.2.2.5 Scour depth and transmitted sedimentation calculation

According to questionnaires results it was observed that: about 53% calculate the scour depth and consider the transmitted sedimentation in sediment basin design before the Inlet, 27% don't calculate anything, and 20% don't give any answer. Figure (59) shows data analysis of scour depth and transmitted sedimentation calculation.



**Figure 59 Scour depth and transmitted sedimentation calculation**

#### 4.2.2.6 Culvert Outlets Design

The multiple response of the questionnaires were 62 out of 44 samples cases. Figure (60) shows data analysis of culverts outlet design. According to questionnaires results the following observation were drawn: about 46.8% design it due to typical drawings and the outlet type; 35.5% use onsite structural designs as needed; 16.1% design it according detailed hydrological study; and 1.6% depending on the nature and type of soil.

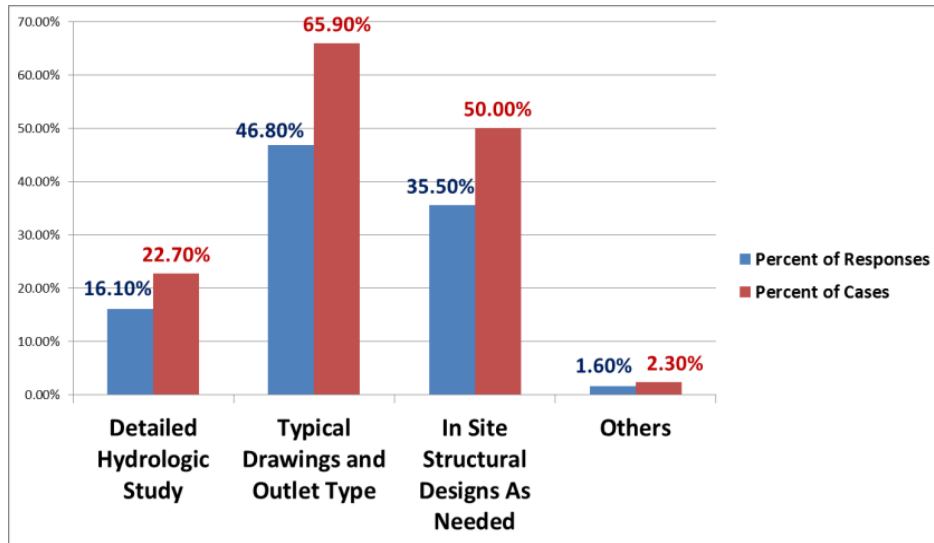

Figure 60 Culvert Outlets Design

#### 4.2.2.7 Culvert Outlet Spill-Way Design

Different points of view were observed according to questionnaires results as follows:

- (1) Making riprap, gradual steps or graded cyclopean concrete protection works up to the solid rock end.
- (2) Hydraulic models should be used; according to ground slope, height, discharge and soil type.
- (3) The outlet flow volume should be controlled to avoid erosion or to be based on solid rock ground.
- (4) The spillway and wings angle should be defined according to the old flow direction.

#### 4.2.2.8 Specific Observations from Engineers point of view on culvert design and problems

##### (A) Technical Issues

There are a lot of culverts problems in road networks which need special attention in culverts designs such as:

- Bad selection of the location and inappropriate orientation of culvert inlet and outlet.



- Some culverts type and dimension are not designed according to hydrologic study and not drained by the amount of water or sometimes there is miscalculation of dimensional needs which cause blockage or erosion of the culverts, damage to culvert walls and erode road body.
- Culverts lengths are not compliance with road section and it always short.
- The use of the ready culverts typical without considering the nature and hydrology of the site.
- The cost constrain the appropriate intervention or not cover the stream requirements need which lead to build an inappropriate culverts or not adequate for the water flow.
- Neglecting to survey the cross-section of specific culverts stations. This lead to none compliance case for culvert dimension with the final design profile elevation and the culvert level may be lowered to cope with the embankments or the final design profile elevation may be increased.
- Sometimes culverts installed in inappropriate locations because of land owners requests due to the social conflicts between them and water rights. And sometimes locals ask for insufficient pipes
- Most culverts outlets are blocked because of agricultural lands or new farms in the area.
- Relying on inexperienced design engineers.

#### (B) Hydrological Data

- Hydrological and hydraulic studies for culverts size and type were taken rarely; with no use of accurate maps and programs in this field and the programs is very weak.
- The 50 years prediction periods of flows not used for culvert design

- Lack and absence of rainfall data and the intensity and duration of precipitation
- Most culverts problems and collapse because of the sediment and the inability of culverts to accommodate the sediments
- Actually water floods are neglected and the design capacity is less than the actual which lead to deficiency in culverts discharge or sometimes lead to collapse.
- The design of inlet & outlet not considered seriously, and inlets are overloaded by flood water and a lot of sediments settled.

(C) Suggestions to improve the culvert design

- A detailed hydrologic study should be done to define culverts locations and dimensions and with material quality assurance
- Choose of culvert materials according to the nature and topography of the region
- Culverts should be designed according to the amount of current and future rain, as well as taking into account the disposal of sediments.
- Culvert type should define according to the slope of catchment area. As in steep slope or wadis should be concrete boxes and in flat areas pipe culverts and in mountains areas masonry culverts due to the materials availability.
- Culverts need special designs related to the nature of the site, and the supervision engineers need training courses to raise their capacity
- Conduct a hydrological study during culverts design for the location and the amount of water flowing to/from the culvert
- Culvert design must be checked during rainy seasons and after medium to high floods.

### 4.2.3. Current Ditches design understanding

#### 4.2.3.1 The dimension and shape of side ditches in road projects

The multiple responses of the questionnaires were 68 out of 44 samples cases. Figure (61) shows data analysis results of defining the dimension and shape of side ditches. It defined according to questionnaires results that about 42.6% use typical designs from Ministry of Public Work and Highway (MPWH) and the experience of the consultant; 20.6 % use detailed hydrologic study; 16.2% defined it due to an offset distance from the asphalt edge to the cut side; 20.6% had other views to define the dimension and shape of ditches such as: the road nature & classification, the amount of water flow, catchment area, type of cut section or the outer edge (rock, steep), the longitudinal slopes, according to economic view beside the shape and size of the landscape, the adaption or improvement of typical designs moreover in most roads it is defined according the available width after the cut excavation.

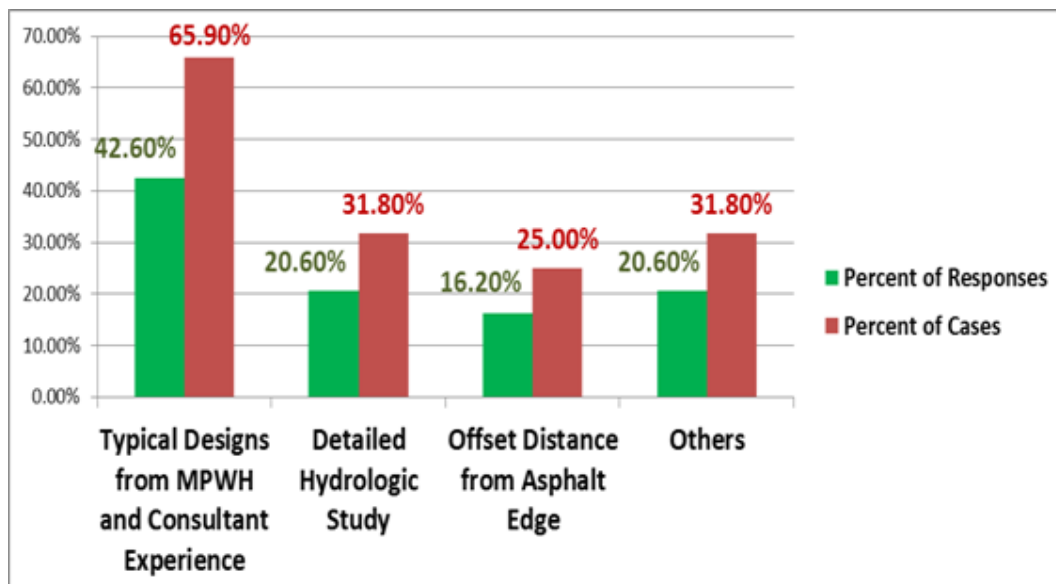

Figure 61 The dimension and shape of side ditches in road projects

#### 4.2.3.2 The longitudinal slope of ditches:

The multiple response of the questionnaires were 65 out of 45 samples cases. Figure (62) shows data analysis results of defining longitudinal slope of side ditches. It defined according to questionnaires results that: about 20% use technical standards; 4.6 % define it according to detailed hydrologic study; 13.8% use typical designs from MPWH and consultant experience; 49.2% design it parallels to the slope of the main asphalt profile with a drop of the ditch depth; 12.3% had other views for design such as: subgrade slopes and cross section slope (superelevation and widening), due to minimum/required slope for discharge and quick on site decision.

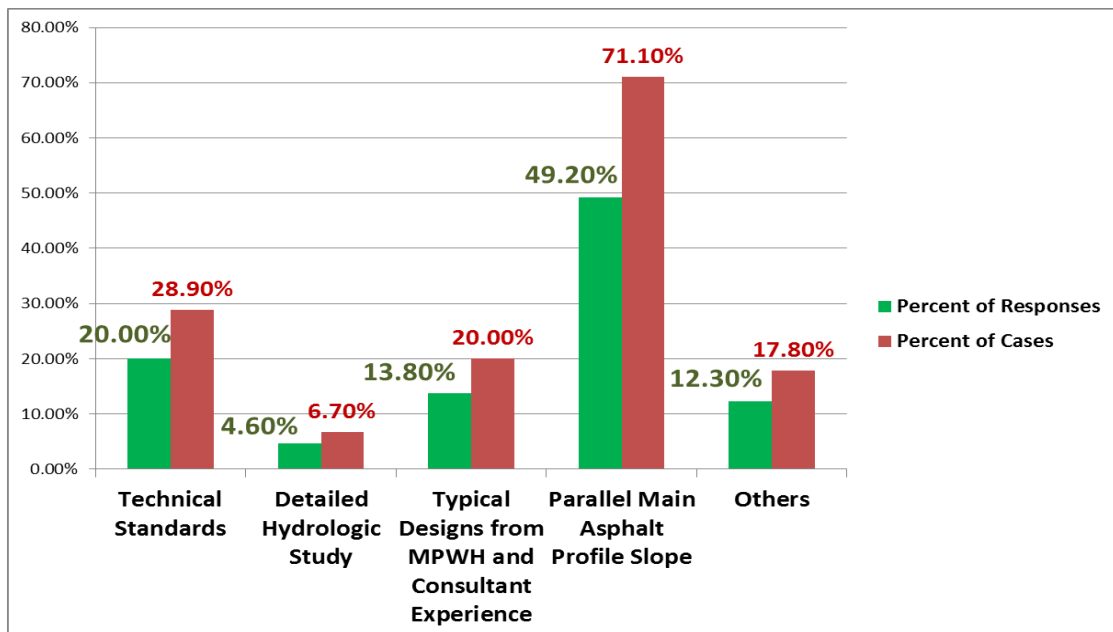
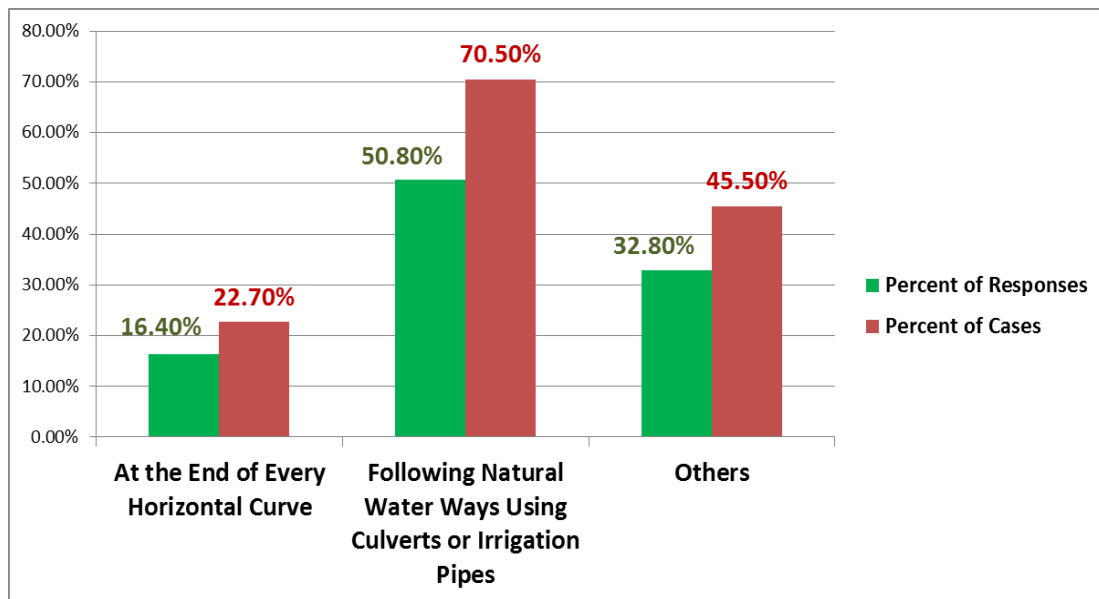

Figure 62 The longitudinal slope of ditches

#### 4.2.3.3 The exit of side ditches

The multiple response of the questionnaires were 61 out of 44 samples cases. Figure (63) shows data analysis results of defining the exit of side ditches. It defined according to questionnaires results that: about 16.4% locate it at the end of every horizontal curve; 50.8% locate it following the natural water ways by using culverts or irrigation pipes to divert water; 32.8% add other views which are : According to: landscape; hydraulic study; amount of water; typical; road site nature (cut or fill); a quick on-site study;

engineer experience; at appropriate outlet either wadi or culvert outlet; at the end of cut sections; at curves allow discharge safely; after excavation phase; the distant between exits should not be more than 300 meters; it defined if the discharge reach to 70% from ditches full capacity; and it transferred to the other edge to the next curve if there is no agriculture lands or houses along the road. Also, appropriate protection work of side ditch exit or mitre drain should be maintained.



**Figure 63** The exit of side ditches

#### **4.2.3.4 Choose the type of the ditches ( Riprap – Concrete – Earthen)**

The multiple response of the questionnaires were 66 out of 41 samples cases. Figure (64) shows data analysis results of choosing the type of side ditches. It specified according to questionnaires results that: about 15.2% choose it due to detailed hydrologic study; 25.8% use typical drawings and according to cross-section type in cut or fill; 31.8% use in site structural designs as needed; 27.3% had other views such as: longitudinal slope of the road; class of road; contract BOQ items; project budget; availability of materials and skills; amount of rainwater; flow volume; outlet flow intensity; velocity; occurrence of erosion; type of soil & topography and according to the consulting and contractor engineers experience.

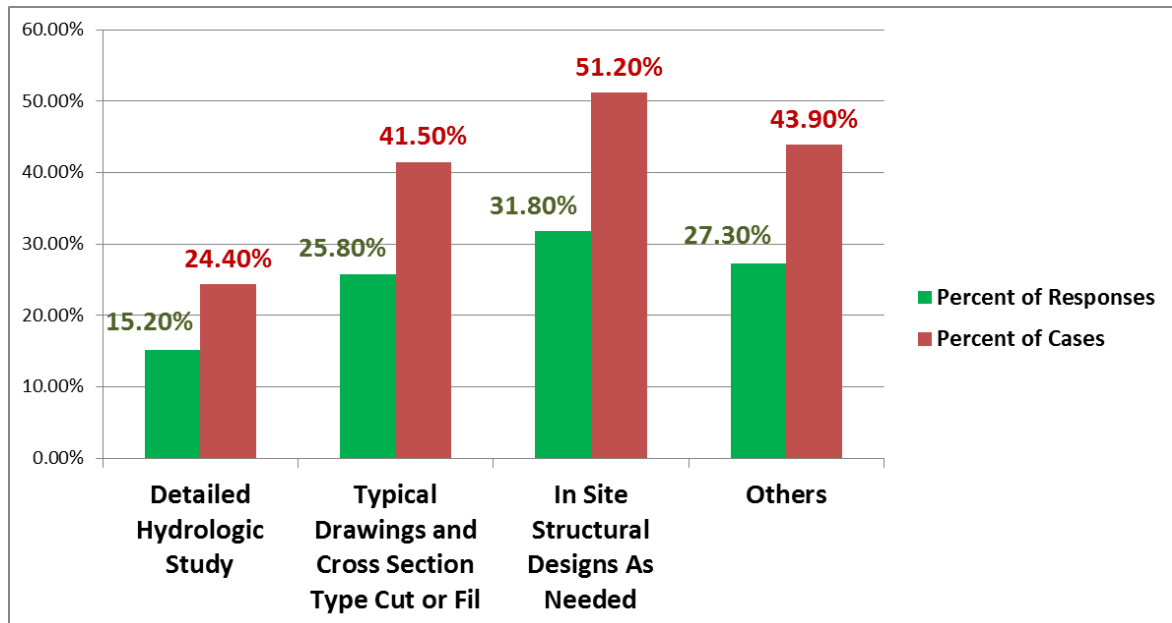

Figure 64 the type of the ditches

#### *4.2.3.5 Specific Observations from Engineers point of view on ditches and road side drainage structure design and problems ...*

The engineers whom express and mention some observations were 29 from the total sample of 45. Their main observation and problems were as follows:

##### (A) Observations and recommendation

- The design, size and type of ditches should be according to hydrological study.
- The use of ready generalized typical drawings and the fixed dimensions of the side drains along the road length should be avoided. Innovation in site should be encouraged and compatible with the region's climate or terrain.
- It is recommended to use exits at intervals to discharge off the ditches during flood in order to reduce the dimension and cost of ditch excavation.
- The ditch out flow should be benefited and water harvesting must be taken in consideration.
- Ditch slope should be considered to avoid erosion and sedimentation.

- Landscape design should be considered to avoid the variable width (zigzag) which was a result of cut section variation.
- In the case of residential places, ditches design must take into account the depth of ditches and the roof slab.
- It is not recommended to use ditches with angled sides due to lack of drainage, the difficulty of cleaning, and the angled sides easy to collapse. It is preferred to use 45 degree angle for sides.
- Design and implementation of ditches must be in high quality to maintain the road sustainability and to avoid frequent damaged and collapse with high maintenance cost.
- Side drainage and ditches in general are earthen except in locations prone to scour and this lined ditches are the function of longitudinal slope and soil type.
- The amount of water in side drainage and ditches is evacuated by using additional culverts if required by the hydrologic study. The wider drain cost is high and not accepted visually if the ratio between the drain width to the road width is high.

#### (B) Problems

- The absence of hydrologic and hydraulic studies, and the structural design only considered.
- Miscalculation of the ditch dimensional needs and sedimentation volume.
- The accumulated debris block the side ditch and the floods forced to use the road surface and caused erosion and damage.
- Not properly designed and executed with low quality and bad materials.
- Not enough to drain the water safely.
- The absence of sedimentation basins along the waterways.
- The type of paving (Concrete – Rib Rap - Earth) were not selected correctly.

- Citizens prevent the implementation of sides drains or request to direct the discharge water to inappropriate places.
- Some road water drainage locations were not compliance with real water drainage which lead to erode the road body.
- Sometimes dimension was decreased to minimize cost.
- The type of ditches is not according to flow velocity and slopes.

#### ***4.2.4. Irish Crossing(IC) structure design***

From the engineers' answers about the design process of the Irish Crossing structures, the following observation defined the IC design according to:

- Hydrological and hydraulic studies.
- The design engineer experience to choose one of the appropriate MPWH typical designs which were studied and calculated in advance.
- The length was defined according to the width of the water stream way (wadi) perpendicular to the road, and the structural design was defined in the site due to the soil type, sediments load, stream banks and plan type.
- The difference in level between the roadway and the level of the waterway & according to the waterway dimensions.
- The nature of the valley (Wadi) regarding the length, height, width of waterway, the amount of water flowing, amount and load of sediments, slope of entrance and exit, cost and BOQ items, the importance of road maintenance after implementation, the traffic intensity and type.
- There are three typical designs of IC (ford, drift and causeway) which used in RAP and depends on the flow volume, slope of the riverbed, scour in the inlet and outlet, the sedimentation



- Irish Crossing should be designed to cover the beginning and end of wadi course i.e. the length of I.C. should accommodate water flow in the wadi.

#### ***4.2.4.1 Specific Observations from Engineers point of view on Irish crossing structure design and problems ...***

The specific observations and problems raised by the engineers were as follows:

- The accumulation of debris on the IC, which sometimes cutoff the road.
- Outlet problem is erosion which usually not considered during design.
- Water inlet barriers and outlet toe wall were not considered correctly to avoid sediments and erosion.
- The location of the IC were not tested with some aesthetical aspect about the IC
- Not enough dimension to discharge water as a result of neglecting the hydrologic study.
- The inlet and outlet should be protected with appropriate slopes to avoid erosion, scour and damage.
- Water signs should be installed in IC location to define the water level and if the traffic can pass the IC or not.
- Irish crossing using should not interrupt traffic flow.
- The longitudinal slope of the wadi was not considered.
- The sedimentation rate of the wadi were not considered to control the level of the IC.
- IC design is based on reducing the cost.
- The final pavement type must be of concrete.
- The amount of flood sediments which closed the road from the first flow of the wadi, construct drainage channels in the IC, calculate the IC height from the level of the wadi and establishment of sediments checks to be cleaned by maintenance.

- There are many problems in the IC, including traffic interruptions during floods, and prefers to be replaced with culverts or flyovers if necessary.
- Main problem uses riprap protection at the outlet. It is recommended to use gabions which considered the best solution as per 24 year of experience.
- Usually floods left remnants or debris on the IC which must be removed and cleaned for example: all IC in Abs-Al-Mahabisha road are covered by sand and gravel and need routine maintenance more than suspension bridges or culverts.
- Impact on traffic flow at the descent of the floods in large quantities and sometimes leads to traffic cutoff at certain times of the year.
- Not enough protection or poor implementation in the inlet and outlet causing erosion, scouring and damage.
- In design and specification no, but the supervision need special attention to execute the specification.
- Most of I.C. are executed with bad quality and it need more attention in the execution phase to assure quality
- IC is used in cases where the wadi can be crossed under all circumstances, low volume flow, low volume traffic
- Sedimentation problems during heavy rains.

### 4.3. Potential road rainwater harvesting

The catchment area for the study watersheds were computed using GIS tool. The study watersheds area consists of 27 sub catchment areas with total area of 73.13 km<sup>2</sup>. Figure (65) illustrate the sub-catchment of the study watershed area with culverts locations.

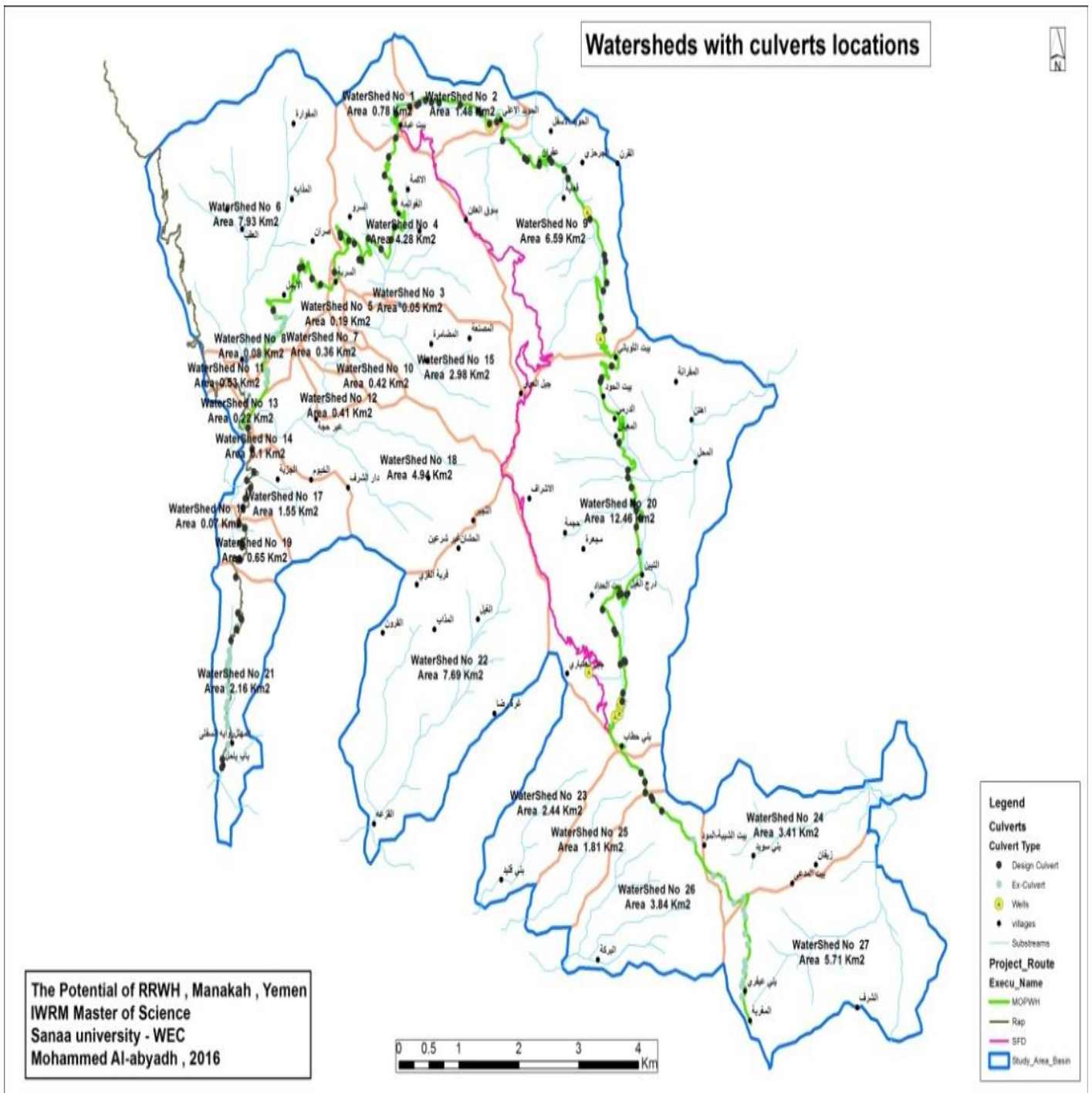

Figure 65 Watershed of the study area with sub-catchment and culverts locations

The potential road rainwater harvesting were calculated for the main and sub-road based on the above outcomes and as follows:

#### ***4.3.1. Main Road Potential Rainwater Harvesting***

Three methods were used to predict the potential rainwater harvesting quantity and show the farmer's initiative for main road as follows:

- (1) Through the whole road length 36 km and with the whole road natural catchment areas (catchment above the road surface), case1.
- (2) At culverts points through 10 km of the road and with reference to culverts catchment characteristics and cross section, case2.
- (3) Five detailed cases for farmer initiative and benefits of road rainwater harvesting structure from case 3 to case 7.

The following steps summarize the general calculation methodology:

- The main road passed through 17 sub catchment areas with total area of 53.58 km<sup>2</sup>
- The 97 designed culverts coordinate for the main road were modified to be adapted with the UTM and projected to the study main road and the 36 executed culverts were surveyed using GPS and projected accordingly. Figure (66) shows culverts location along the study main road.
- All the data set from GIS for sub catchment areas of the study watershed including culverts and water harvesting structures were projected to GOOGLE EARTH, after that the area tool was used to define the road natural catchments and culverts catchments area.

-

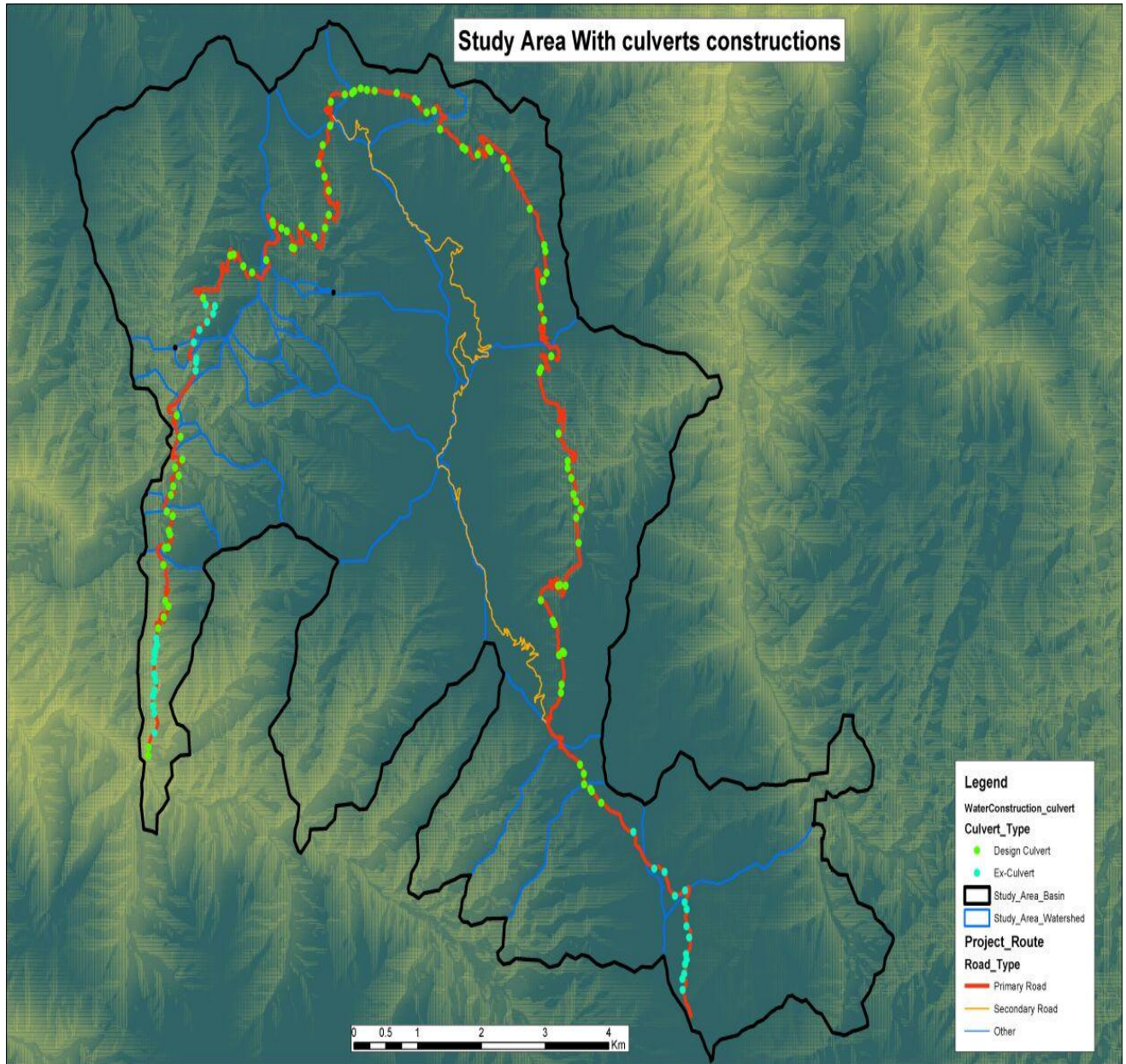

**Figure 66 Culverts location along the main study road**  
**4.3.1.1. Case 1 road natural catchment**

In this case the road natural catchment areas which can be defined as - part area from the sub catchment areas and had an affected on the road rainwater harvesting which consist of the culverts catchment and strip catchment - is used to calculate the potential RRWH quantity from the main road natural catchment. Figure (67) shows a sample of culverts and strip catchment of the road natural catchment.



**Figure 67 a sample of the road natural catchment area which is calculated by Google-Earth tool**

In addition, Table 1 shows the detailed calculations of the sub-catchment areas and road natural catchment areas with the culverts number and type in each sub-catchment.

**Table 1 Main Road natural catchment and intersected sub-catchment areas with number and status of culverts.**

No.	Sub-Catchment Category	Sub-Catchment Area (Km2) (1)	Road Natural Catchment Area (Km2) (2)	Percentage of (2) from (1)	No. of Culverts	Culvert Status
1	27	5.71	0.38	6.65%	10	Executed
2	24	3.41	0.11	3.23%	4	Executed
3	26	3.84	0.26	6.77%	4	1 Executed / 3 Design
4	25	1.81	0.22	12.15%	3	Design
5	20	12.46	2.54	20.39%	23	Design
6	9	6.59	2.86	43.40%	15	Design
7	2	1.48	0.36	24.01%	10	Design
8	1	0.78	0.09	11.54%	2	Design
9	4	4.28	0.64	14.95%	16	Design
10	6	7.93	0.66	8.32%	10	5 Executed / 5 Design
11	8	0.08	0.02	25.00%	1	Executed
12	11	0.53	0.16	30.19%	3	Executed
13	13	0.22	0.02	8.00%	1	Design
14	14	0.1	0.07	70.00%	1	Design
15	17	1.55	0.31	20.00%	5	Design
16	19	0.65	0.49	75.38%	6	Design
17	21	2.16	0.66	30.56%	19	12 Executed / 7 Design
<b>Total</b>		<b>53.58</b>	<b>9.85</b>	<b>18.38%</b>	<b>133</b>	

The (calculated) main road natural catchment area is 9.85 km<sup>2</sup>.

The potential RRWH which generated from the road natural catchment by assuming its using runoff coefficient of 0.65 with the (Main assumptions) is 1,662,729.25 m<sup>3</sup> per year.

#### *4.3.1.2. Case 2 for 10 km from the main road.*

In this case study 10 km length of the main road was selected to estimate the potential of rainwater harvesting at culverts location, and define the potential suitable locations for water harvesting at culverts outlets.

Total culverts exist in this length are 40 culverts and the road intersect and pass along 5 sub-catchments of the study area watershed. The catchments were defined at the culverts points by calculating the road surface and culverts catchments, then the culverts

outlets type were defined according to the land use of the surrounding area to find out the potential locations of RRWH.

#### Catchment Area:

Two catchments were defined as follows:

1. **Road catchment:** The catchment width of the road surface was computed for 10 m width and catchment length and slope were calculated for each culvert by using the road profile and culverts location to define the accumulated catchment length at each culvert location.
2. **Culverts catchment:** represent the concentrated flow from the catchments upper the culverts. These catchments areas were calculated using GOOGLE EARTH area tool or as strips areas. Figure 68 shows a sample of the culverts catchment area which is calculated by Google-Earth tool.

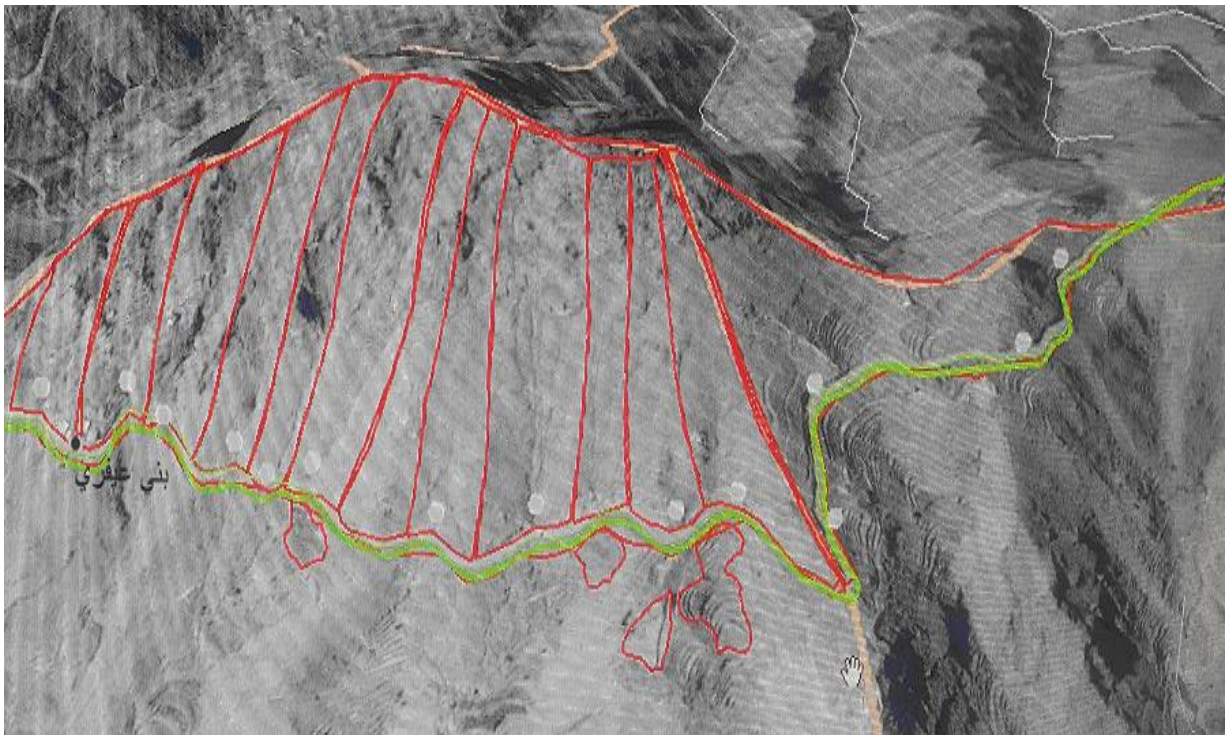

**Figure 68 a sample of the culverts catchment area which is calculated by Google-Earth tool**

The following assumptions were taken beside the **Main assumptions** to calculate the potential rainwater harvesting at culverts location.



## a) Runoff coefficient

1. Road surface runoff factor of 0.85,
2. Culverts catchment runoff factor are varying according to catchment characteristics and slopes; the details is given in table no. 2 as a sample calculation.

b) Calculations & Findings

The total potential RRWH which generated from 10 km at 40 culverts location equal to 529,178.31 m<sup>3</sup> (from culverts catchment 516,474.44 m<sup>3</sup> & from road catchment 12,703.87 m<sup>3</sup>).

The detailed results were presented in table no. 2. The culverts outlets type was defined according to the land use of the surrounding area in order to find out the potential locations of RRWH. The obtained results were as following:

- According to the culverts outlet characteristics there are only 22 culverts locations which are appropriate for potential water harvesting, while the 18 culverts located either in stream ways, steep slopes or stepped the road alignment.
- The amount of potential harvested water at the appropriate culverts locations equal to 188,446.87m<sup>3</sup> (from culverts catchment 180,908.43 m<sup>3</sup> & from road catchment 7,538.44 m<sup>3</sup>) which represent 36% from the total generated water volume for the 10 km length case.
- There are 13 existing water harvesting structures along the 10 km length: three are at executed culverts outlets at station (800, 1400 and 3025), two are at design culverts locations at station (5675 and 6325), and the remaining 8 are near the road which use the road surface, humps, channels, spillways to divert and harvest road rainwater.



Table (2) shows a calculation for Potential RRWH at culverts locations for the main road surface and culvert catchment. It also contains the runoff factor for each catchment, culverts inlet and outlets land use. Moreover, the table colours refer to the different sub-catchments of the watershed which intercept with the road.

The potential RRWH at the 10 Km length can be expressed as a percent of the total culverts by 55 % as 22 culverts location can be used as RRWH structures near the terraces while only 4 of which already had tank structures.

The road and culverts catchments were compared with the study area watershed sub-catchments areas it shows the small percent of the road catchment.

**Table 3 road and culverts catchments percent from sub-catchments area**

Sub catchment area Km2	No. of culverts	Culverts catchments Km2	Culverts catchments %	Road Catchment Km2	Road Catchment %	Culverts & Road catchments Km2	Culverts & Road catchments %
5.71	10	0.4057	7.1%	0.0365925	0.6%	0.4422925	7.7%
3.41	4	0.075	2.2%	0.0169125	0.5%	0.0919125	2.7%
3.84	4	0.118675	3.1%	0.0242925	0.6%	0.1429675	3.7%
1.81	3	0.1172	6.5%	0.0074825	0.4%	0.1246825	6.9%
12.46	19	3.51645	28.2%	0.1214625	1.0%	3.6379125	29.2%

#### 4.3.1.3. Case 3 Water Harvesting Tank Calculation

In this case a detail study for farmer initiative to use rainwater from box culvert outlet and store the harvested water in a tank, the farmer uses the harvested water to irrigate Qat terraces.

At station 1+400 a (1×1) box culvert outlet ends with an earthen pond as temporary sedimentation and storage facility where the farmer conveys the water to the water harvesting tank by gravity using a plastic tube as shown in Figure (69).

Tank's volume =  $(20 \times 10 \times 5) = 1000 \text{ m}^3$

Catchment area: The catchment is 75 m length from station 1475 to the station 1400.

1- Road catchment area is  $750 \text{ m}^2$

2- Culvert catchment area is 21,898 m<sup>2</sup>

Potential harvested rainwater: using the (Main assumptions) and runoff catchment coefficient of 0.75.

Potential harvested rainwater = 4430.742 m<sup>3</sup>

Qat Terraces Area: (1)New Terraces area = 3174 m<sup>2</sup> with about 260 trees, (2) Old terraces area = 7726.92 m<sup>2</sup> with about 330 trees, Total area = 10,900.92 m<sup>2</sup> and total trees = 590.

Qat Crop Requirements: The water consumption per tree is 100 liter per irrigation where each season need about five irrigations to be conducted. For this location qat water requirement with assuming the trees irrigated five times per season, where the needs are estimated by farmers to be about 100 liter for each tree in each irrigation).

$$= 100 \times 590 \times 5 = 295,000 \text{ liter} = 295 \text{ m}^3$$

Qat Yields : Yield [Tons/ha] = 1 Source: Agricultural Statistics Year Book (MAI, 2000a) by Ali Abdulmalek Alabsi, FAO, 2006

Terraces Qat Yields = 1.090092 × 1 = 1.090092 tons = 1090.092 kg

Total RRWH = 4430.742 m<sup>3</sup>

Qat Needs =295 m<sup>3</sup>



**Figure 69** Water harvesting tank at the culvert outlet, (left picture) shows the temporary sedimentation and storage pond and the plastic tube to transfer the water to the harvesting tank (right picture)

RRWH Balance =  $4430.742 - 1000 = 3430.742 \text{ m}^3$  minus 30% losses ( $1276.123 \text{ m}^3$ ) =  $2154.620 \text{ m}^3$  per year were lost.

#### ***4.3.1.4. Case 4 RRWH from road surface and side ditches.***

In this case a detail study for farmer initiative to use rainwater from the inner side of the road cut section as it is guided in an earth and stone ditch after the culvert inlet at station 1+400 to the station 1+250 where an earthen hump was used to divert the collected water to the coffee terraces near the road while the nearest box culvert (1×1) is located at station 1+180 at 70 m distance from the hump.

The farmer initiative summarized in the following:

- Dry stone ditch at the inner side of the roadway and the maintenance is carried out recently as in the photos Figure (70).
- Dry diagonal side check humps were used at the outer edge of the left horizontal curve to reduce the erosion in the road surface and to guide the surface runoff.
- At the hump spillway no erosion control was used by the farmer but at the terraces level a dry stone wall was used and there is accumulated transmitted sand near the wall.

Site technical description: the total length of this section is 150 meter and the slope of the center profile is 6.6667 %. The cross section shows that the stations 1400 to 1325 were cut box with ditch in each side, while in the site and due to the manmade activities the outer right ditch is wiped out. And from station 1300 to 1250 there are cut/fill sections & left horizontal curve.

The case: in this case it is clear that there is a water right at this station by directing the collected rainwater to the coffee terraces and the problem that may occur after the road had been implemented such as asphalt and the side ditch protection work.

Catchment area:

The catchment calculated for 150 m length from station 1400 to the station 1250.

1. Road catchment for 150 m length and 10 m width is 1500 m<sup>2</sup>
2. Strip catchment equal to 30,094 m<sup>2</sup>

Total Catchment Area = 31,594 m<sup>2</sup> = 3.1594 ha

Potential harvested rainwater: using the (Main assumptions) and runoff catchment coefficient of 0.75.

The potential harvested water = 6,153.72135 m<sup>3</sup>

The potential harvested water with the second equation by Van der Gun, et al.,1995

Runoff (mm) = 0.055 × Precipitation (mm) = 0.055 × 371 = 20.405 mm = 0.020405 m

The potential harvested water = Runoff (m) × (Road catchment area + Strip catchment area) = 0.020405 × (1500 + 31,594) = 675.28 m<sup>3</sup>

Coffee Terraces Area: 2705 m<sup>2</sup> = 0.2705 ha

Catchment Area (C) / Cultivated Area (CA) = 3.1594/0.2705 = 11.68 = 1168 %

Terraces Retention Capacity:

Terraces ridges height 10-20 cm

Assume terraces ridge height = 0.2 m

Retention capacity = Terraces Area × Terraces ridge height = 2705 × 0.2 = 541 m<sup>3</sup>

Coffee Tree Crop Requirements:

Per tree 40-50 liter each two weeks or 80 litres per tree as emergency irrigation when rain delay

Number of coffee trees approximately 145 trees, as the average approximate distance between coffee trees between 2.5 to 3.5 m

For this location coffee water requirement if assuming the trees where irrigated five times per season each year as farmers estimate each irrigation need 50 liter for each tree will be equal to 36,250 liter

$$= 50 \times 145 \times 5 = 36,250 \text{ liter} = ( 36.25 \text{ m}^3 )$$

### Coffee Yields

Yield [Tons/ha]=0.4 Source: Agricultural Statistics Year Book (MAI, 2000a) by Ali

Abdulmalek Alabsi, FAO, 2006

$$\text{Terraces Coffee Yields} = 0.3 \times 0.4 = 0.12 \text{ tons} = 120 \text{ kg}$$



**Figure 70** These photos show the farmer technique to harvest water across the road using dry stone check walls (along the road and skew)



**Figure 71** Road Rainwater Harvesting to Coffee Terraces using Earth Hump and Dry stone check walls.

#### 4.3.1.5. Case 5 Water harvesting tank (Bait Al-Shibah):

In this case the farmer construct two temporary check walls (humps) to intercept the running water and dug a channel near the road outer edge to convey the water to a cement mortared tank with approximate volume of 1170 m<sup>3</sup> (26 length × 9 widths × 5 height). The farmer suffers to harvest the water by using two temporary check walls and he used a channel to convey the water but it still insufficient where the farmer uses a pump with plastic tube to convey the water to the tank from the interceptor's humps.

Technical description: the technical review of the design profile shows that the tank is located near the road right edge parallel to station 2+675 in an elevated 6.0 % up slope along the profile, and the two earthen humps where located at stations 2+575 and 2+625 with the same elevated 6.0 % slope. The nearest executed box culvert located at station 2+475 in a flat 0.0 % slope, as in Figure (72).

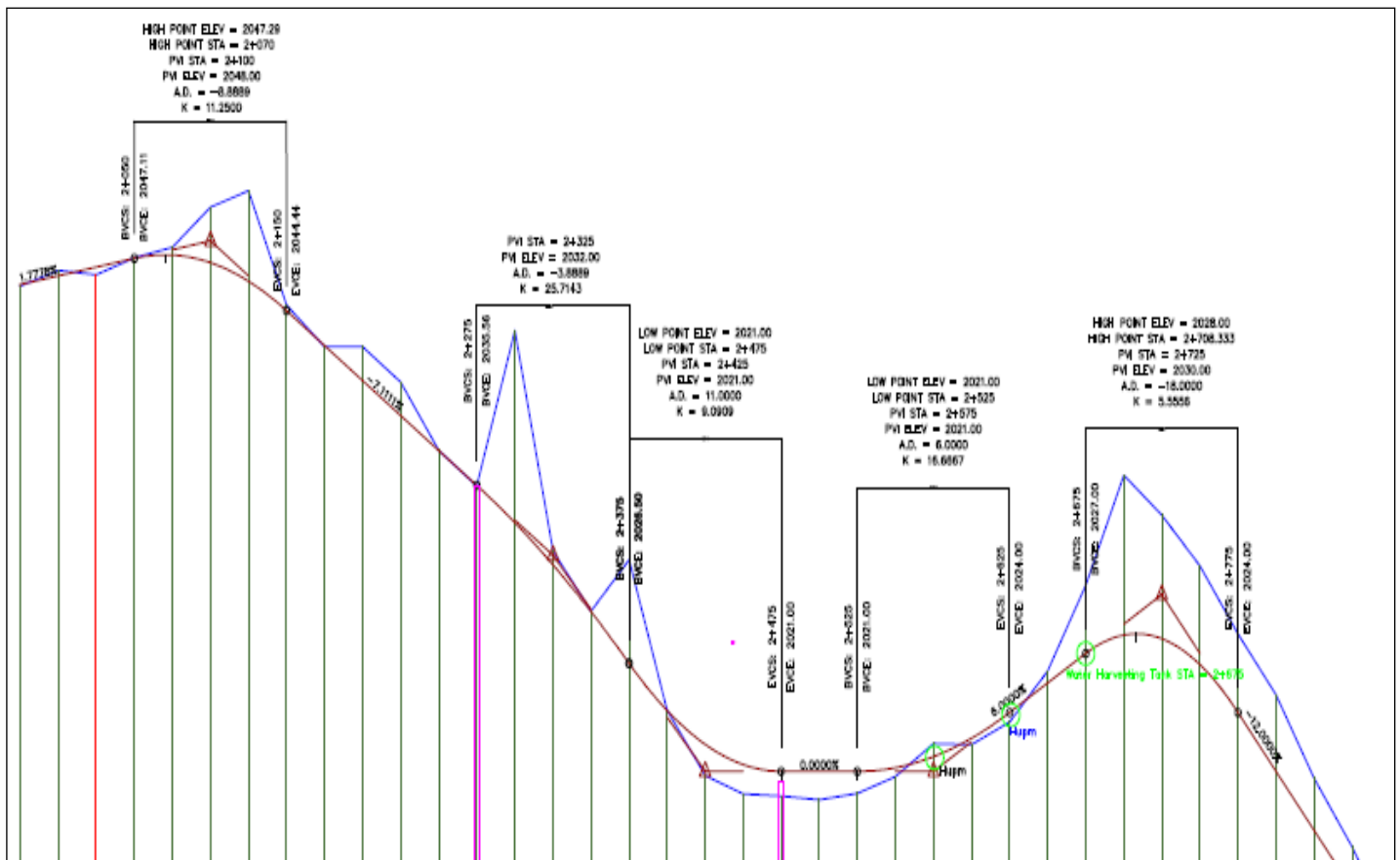

Figure 72 Road geometric vertical profile section from 2050 to 2800



Green circles show the water harvesting tank and the earth humps which located in the up-slope section.

The Case Problem:

From the field notice and from the interviews with some farmers in the study area the farmer wants to harvest and divert the water upwards even by using a pump. This was assured by the technical review of the design profile.

The other problem which is noticed is the leakage of water from the tank that indicate the absence of technical knowledge of construction or improper implementation.

Catchment area:

The catchment calculated for 125 m length from station 2575 to the station 2700 with 100 m zero slope length from 2475 to 2575.

1. Road catchment for 225 m length is 4,613 m<sup>2</sup>
2. Bait Shibah hill catchment equal to 10,800 m<sup>2</sup>
3. Strip catchment equal to 7,150 m<sup>2</sup>

Total Catchment Area = 22,563 m<sup>2</sup>

The road catchment for the length before the culvert location at 2475 from (2275 to 2475) and the culvert external catchment where not considered. As illustrated in Figures 73 and 74.

Potential harvested rainwater: using the (Main assumptions) and runoff catchment coefficient of 0.75.

Total approximate harvested water per year = 4394.7 m<sup>3</sup> / year

And by considering the two rain seasons and assuming the same quantity of rainfall for each season.

Total approximate harvested water per Season = Total approximate harvested water per year / 2 = 4394.7 m<sup>3</sup> / 2 = 2197.35 m<sup>3</sup> / season

The ratio of stored RRWH can be represented by dividing the volume of the tank 1170 m<sup>3</sup> and the potential harvested water per season = 1170 / 2197.35 = 53.25 %



Figure 73 Water harvesting tank from road surface in Bait Al-Shibah village

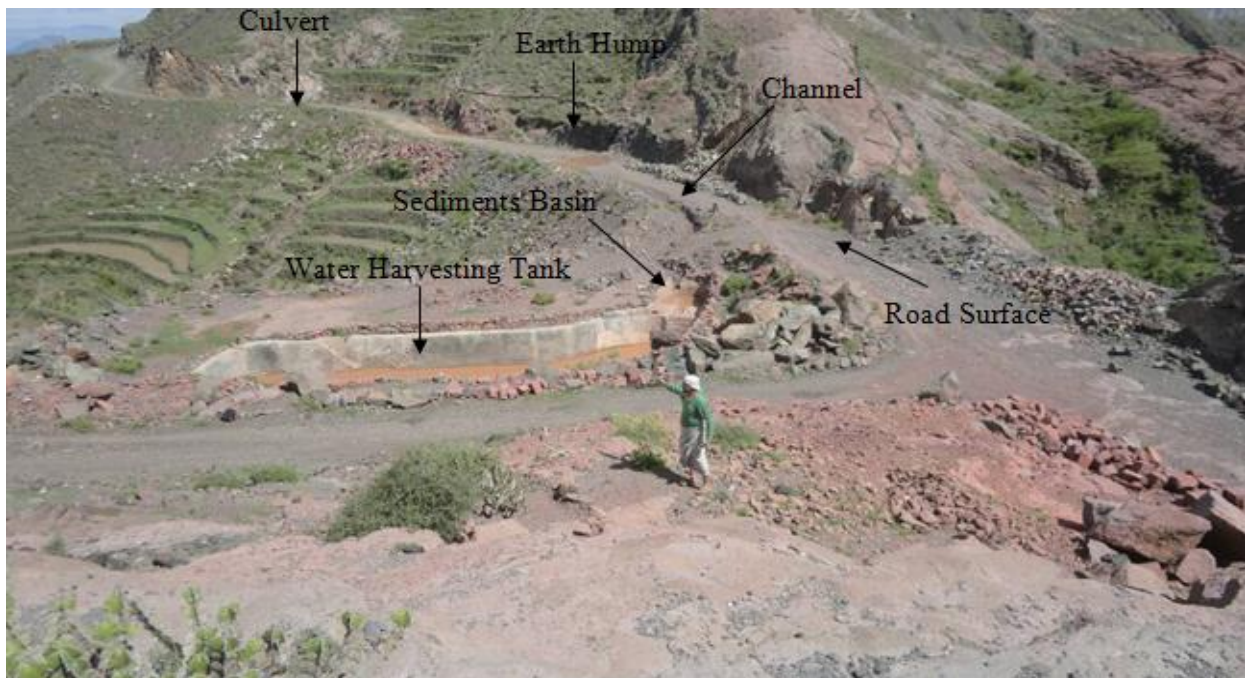

Figure 74 The earth hump which constructed by the farmer to intercept the road runoff and the right water channel but as the gradient is up-sloped the farmer use a plastic tube to convey the intercepted water to the tank by using in situ pump. It also shows the hill and part of the strip catchments.

#### 4.3.1.6. Case 6 RRWH from box Culvert outlet

In this case the outlet of the box culvert ( $1.5 \times 1.5$ ) at station 3+025 was leaded to a small pond with rock escarpment side and stone masonry wall (GADHADH) in the other side with approximate volume of  $300 \text{ m}^3$  ( $15 \text{ length} \times 8 \text{ widths} \times 2.5 \text{ height}$ ).

There is check dry wall at the culvert outlet was installed and it act as filter and to reduce the transmitted sediments with steps spillway to the next check dry wall before the sediments trap, (As illustrated in Figure (75)).

The catchment area: the catchment area divided to two parts

Road surface catchment:  $3150 \text{ m}^2$  starts from station 2+725 the total length of the road section is 300 meter with 12% downslope and the cross section of this section were almost cut box section with 10 m width of road surface the runoff coefficient is assumed 0.75.

Surrounding upstream catchment area (culvert catchment):  $22,950 \text{ m}^2$  about 80 % agriculture terraces runoff coefficient is assumed 0.45.

Potential harvested rainwater:

The potential harvested water with average annual rainfall of 0.371 m, and efficiency factor of 0.7 will be as follows:

- 1- Harvested water from Road catchment  $584 \text{ m}^3$
- 2- Harvested water from Culvert catchment  $2682 \text{ m}^3$

Total approximate harvested water  $3266 \text{ m}^3 / \text{year} = 1633 \text{ m}^3 / \text{season}$

Ratio of Stored RRWH = Volume of RRWH structure / (Volume of Potential RRWH / Season)

$$= 300 / 1633 = 18.37 \%$$



**Figure 75** Water harvesting pond from culvert outlet

#### ***4.3.1.7. Case 7 RRWH from 1×1 box Culvert outlet at station 28+475***

In this case the farmer (Abduh Sagheer Esmaeel) already harvest the rainwater from the box culvert at station 28+475 outlet to water harvesting tank in Al-Dhola'a village with approximate volume of 540 m<sup>3</sup> (18 length × 6 widths × 5 height). Also there are 3 water harvesting tanks above the cut side of the road.

The case problem: The farmer constructs an earth hump at a distance between 5 – 10 meter after the culvert location and he claimed that the contractor promised him to construct another culvert or irrigation pipe near the executed one. But from the interview with the farmer the researcher foresees the real problem as a conflict between

brothers about the land parts and their catchment (water right). Multi check dry walls where installed at the culvert outlet and stepped to reach the tank.

Figure (76) shows the water harvesting tank and the earth hump which constructed by the farmer to divert the water to the tank.



**Figure 76** Water harvesting pond from culvert outlet

#### ***4.3.2. Water harvesting balance for main road***

For the main road the water harvesting balance calculation for the existing water harvesting structures in the main road was estimated by assuming the average volume of each structure to be  $660 \text{ m}^3$  (this average volume assumed from questionnaire results).

The total structures along the study road = 33

Average potential water harvesting in structures =  $33 \times 660 = 21,780 \text{ m}^3$ .

From case 2 if we consider the result of potential suitable location as a percent of 36% and use it to calculate the potential RRWH which will be harvested from road natural catchment

$$\text{Calculated potential WH from road natural catchment} = 36\% \times 1,662,729.25 \text{ m}^3 = 598,582.53 \text{ m}^3$$

This amount is supposed per year if we divided it by two (the two rain seasons) = 299,291.265 m<sup>3</sup>

$$\text{Water Harvesting Potential Ratio} = 21,780 \text{ m}^3 / 299,291.265 \text{ m}^3 = 7.28 \%$$

$$\text{Water Harvesting Potential structures needed} = 299,291.265 \text{ m}^3 - 21,780 \text{ m}^3 = 277,511.265 \text{ m}^3 / 660 = 420 \text{ structures}$$

### ***4.3.3 Sub road Potential Rainwater Harvesting***

Two methods were used to predict the potential rainwater harvesting quantity and show the farmers initiative for the sub road as follows:

- (1) Through the road length 16 km. case8
- (2) detailed study of the underground cisterns initiatives, case 9.

#### ***4.3.3.1 Case 8 Through the road***

In this case the sub-road lay at the top border line of the sub-catchments area so only the road surface of 4 m and strip natural catchment of 4 meter will be used to predict the potential rainwater harvesting quantity from sub road 16 km length. And the runoff factor is assumed 0.75 with the (Main assumptions).

The potential RRWH which generated from 16 km is 24,931.2 m<sup>3</sup>.

#### **4.3.3.2 Case 9 Underground Cistern**

In this case a detail study for farmer's initiatives related underground cistern in the sub road were selected to show farmer's indigenous harvesting techniques.

This underground cistern excavated manually in the soft tuff rocks as caves or use arched stone roof. Sediments traps, stone spiral stairs and steel bars doors or steels panels doors were used in some cisterns.

The case problem:

The main source of water in this area is rain and the farmers face water scarcity during dry periods of the year. Therefore, the farmers dug a number of 16 underground cisterns in natural tuff soft rocks in the inner edge of the mountain or under/near the houses to collect runoff and store it to dry season along the sub-road section which located in the upper catchment border. Figure (77) shows the typical drawing sections for some cisterns, which rehabilitated by the Nama'a NGO with support from UNDP. Figure 78 shows some photos of constructed cisterns near the houses, under the house and beside/along the road in the inner side of the mountain.

Technique description:

1. Using traditional hand tools and manpower to excavate the soft tuff rocks as caves,
2. Building the edges of some cisterns with masonry small rocks wall if the edges contain clay or sand,
3. Using cement plastering to cover the cistern walls to reduce and prevent seepage,
4. The cistern roof either natural stone like cave or arched stone roof,
5. Stone spiral stairs were used and stone openings act as entrance to the cisterns and for water with steel bars doors or steels panels doors.
6. Sediments traps were used in some cisterns.

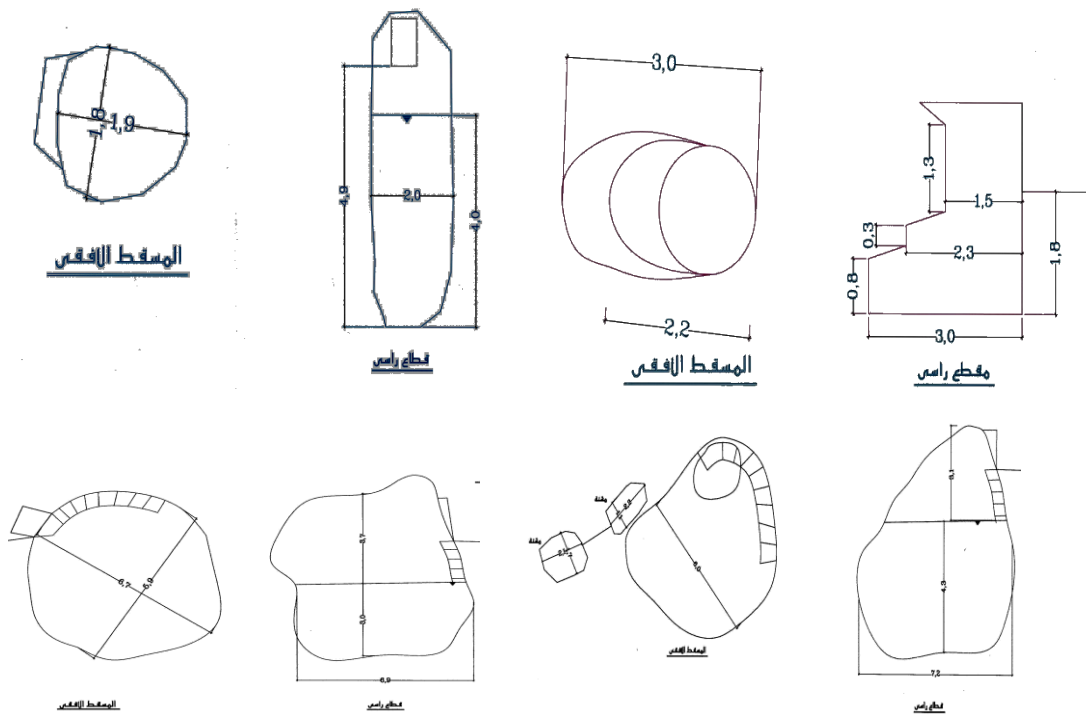

Figure 77 Typical drawing sections for some cisterns (Source : Dr. Ali Al-Ghail - Nama'a NGO)



Figure 78 Cisterns along the sub road

The catchment area: The main catchment area is the road surface and the adjacent mountainous slopes by the road which located at the top catchment of the study area.

Average Volume: The average volume varies from small to large cisterns and can be estimated from four samples to be  $60 \text{ m}^3$ .



#### ***4.3.4 Water harvesting balance for sub road***

For the sub road the water harvesting balance calculation for the already surveyed water harvesting structures along the sub road was estimated by assuming the average volume of each structure to be 60 m<sup>3</sup> for cisterns from case 5 and an average of 660 m<sup>3</sup> for tanks.

The total structures along the study road = 57 (21 underground cisterns & 36 tanks)

Average potential water harvesting in structures =  $21 \times 60 + 36 \times 660 = 25,020 \text{ m}^3$

## ***4.4. Current Geometric design***

In this thesis research to define the role of geometric design in water harvesting a review of the main road current geometric design were conducted, some technical issues which observed during the field visit were addressed and some of the geometric parameters that may affect the road drainage were discussed.

### ***4.4.1 Current Geometric design overview of the main road***

The study road consists two parts, the first part starts from Maghrabah Manakah and ends in Al-Jazabah village with a total length of 30.5 Km and implemented by a general contractor under the direct supervision of MPWH and donor by government central fund. The second part starts from Al-Jazabah village and ends at Bab-Bahil with total length of 5.5 Km and implemented by a general contractor under the supervision of Rural Access Program (RAP) which is under the supervision of MPWH and financed from foreign fund. The two parts are under construction phase such earth work excavation and levelling of sub grade and civil work construction for some culverts. Meanwhile, there are a different in the local coordinate system for the survey works for two sections which reflect the unplanned coordination between MPWH agencies.

- Horizontal alignments:

In this 36 km, the number of curves is 770 curves; this indicates that the road is of very low geometric standard with an average of one curve per 47 m or an average of 21 horizontal curves per each kilometer. **On the other hand, the number of horizontal curves may be used as an indicator for the potential points of RRWH in means of lead out ditches.** The horizontal curves categories are summarized in table 4 as follows:

**Table 4 Main Road Categories of Horizontal Curves Radius**

Curves with radius ( R )	Number	Percent
$R \leq 10$	50	6%
$15 > R > 10$	60	8%
$30 > R \geq 15$	150	19%
$40 > R \geq 30$	83	11%
$50 > R \geq 40$	70	9%
$60 > R \geq 50$	75	10%
$90 > R \geq 60$	97	13%
$200 > R \geq 90$	131	17%
$R \geq 200$	54	7%
<b>Total Curves Number</b>	<b>770</b>	

-Vertical Profile:

The vertical profile starts at an elevation of 2000m (asl) and end at an elevation of 1200 m (asl). The 800m difference in elevation is descended by a number of 190 PVI's along the 36.5 km of study road which represent an average of 5 vertical curve per each kilometre. With variance in vertical design profile slopes the maximum slope is 21.33 % & - 16.78 % , While in Google Earth profile the maximum slope is 30.1 % & - 32.7 % and the average slope is 8.3 % & - 9.6 % . **The number of vertical sag curves may be used as an indicator for the potential points of RRWH in means of culverts or Irish Crossing.** Figure (79) shows Google Earth profile of the main study road.



**Figure 79 Google Earth Profile of the main study road**

- Drainage structures:

\*Culverts: there are 36 executed and under execution (suspended) culverts distributed at the beginning and at the end of the study road in addition to 97 suggested design culverts. The 97 design culverts coordinate at the main road were modified to be adapted with the UTM and projected to the study main road, while the 36 executed culverts were surveyed using GPS and projected accordingly. Figure (80) shows culverts location along the study main road.

The culverts along the main road represent an average of 3.6 culverts per each kilometre which may be used as indicator for the potential RRWH locations.

\* Side ditches, channels, check diversion humps and culvert or ditches outlets: this road is under construction and the works had been sustained since 2011.

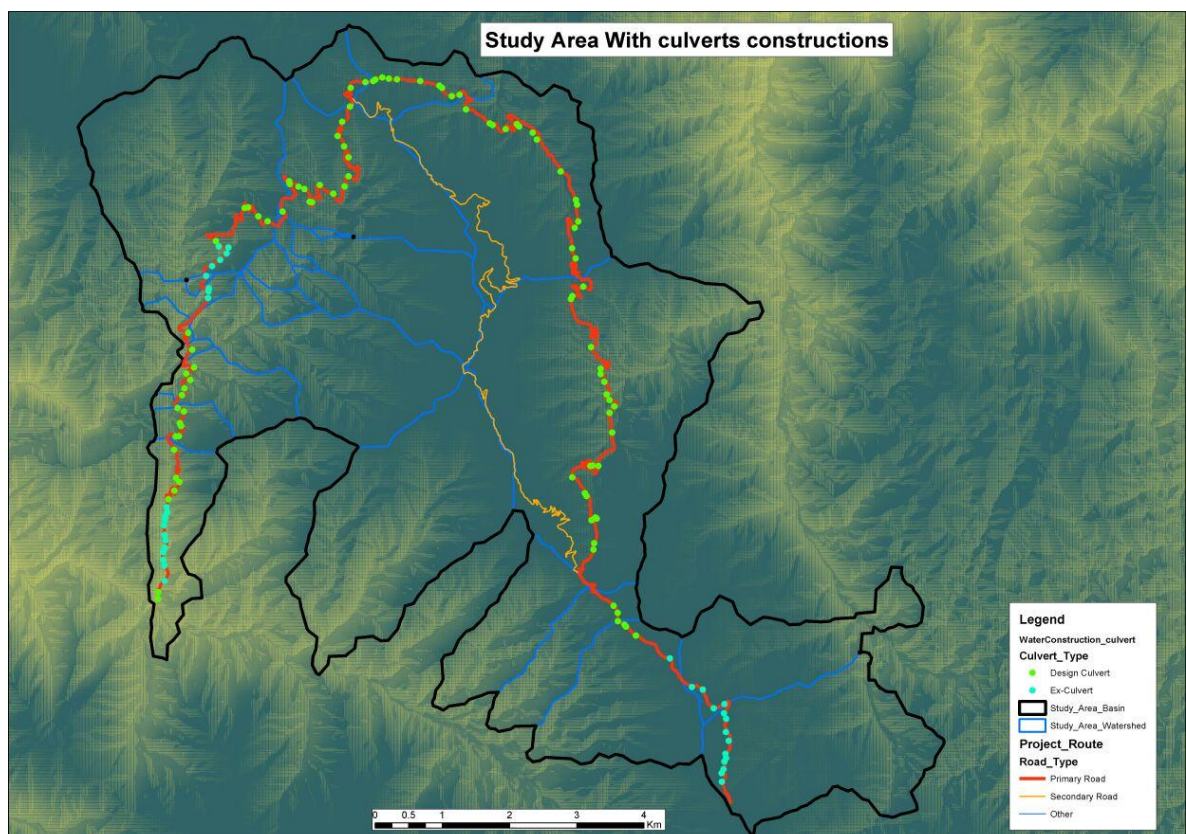

Figure 80 Culverts location along the main study road

From the field visit and technical review, the following points were addressed:

- There are lack of coordination to use unified coordinates systems that is reflected in the two parts of the study main road.
- The road drainage structures (culverts) in main road are not installed in the design drawing except the location of culverts in the profile and the dimension and type in separate table.
- The ditch dimension is defined at cut sections of the cross sections at equal intervals of 25 m for the road alignment stations and neglect the lead out points .
- The cross section vary according to the topology and there are box cut section or one cut side (left or right), while the design cross sections were at equal intervals (stations), while there is neglecting for the discharge points of these ditches when the section changed from cut to fill especially in the outer side of the section.
- Most protection works of the road defined after the asphalt layer construction.

#### ***4.4.2 Current Geometric design overview of the sub road***

It has been implemented through community based contracting mechanism by local contractors and funded by SFD in two stages. The cumulative scattered stone paved length is about 8 Km and with average width of 4 m.

-Horizontal Alignment: approximately 285 horizontal narrow to slight composite and overlapped curves were observed using Google Earth and it follows the existing route

-Vertical Profile: the vertical profile starts and ends with an approximate same elevation of 1858 m with an average elevation of 2152 m and maximum elevation of 2400 m, the maximum slope along the profile is 52.1% and -38.7 and the average slope is -/+12.1%.

Figure (81) shows Google Earth profile of the sub study road.

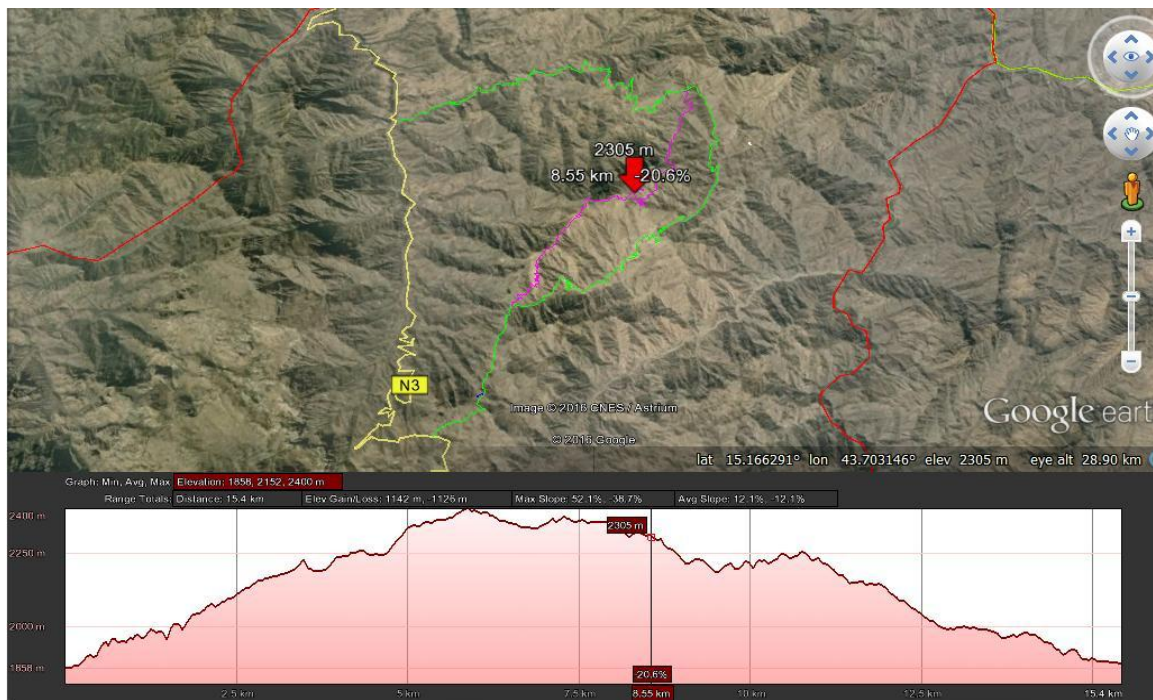

**Figure 81- Google Earth Profile of the sub study road**

- Drainage structures:

The main drainage structures in stone paved roads is road surface channelled by the mountain rocks or small side ditches in the inner side and with stone curbs, rocks or tree shrubs in the outer side, the main drainage were diverted using cross diversion structures such as stone rolling dips or retaining walls spillways and sometimes parallel channels.

# **CHAPTER FIVE**

## **DISCUSSION**

## CHAPTER FIVE DISCUSSION

### *5.1. Potential RRWH Results*

#### - In (case 1).

- The road natural catchment characteristics which is a part of the watershed sub-catchment and consist of culverts catchment and strip catchments influence the potential RRWH quantity
- The estimated potential RRWH quantity from the main road natural catchment is 1,700,000 m<sup>3</sup> .
- The road natural catchment represent about 18.38 % (9. 85 km<sup>2</sup>) from the total sub catchments (53. 58 km<sup>2</sup>) of the watershed, which give an indication for the little effect to the downstream stakeholders if the whole road natural catchment yields were harvested and used by the upstream stakeholders.

#### - In (case 2).

- The total in general RRWH which is generated from 10 km length at 40 culverts location equal to 529,000 m<sup>3</sup>. The total potential RRWH which is generated from culverts catchment 516,474.44 m<sup>3</sup>, that represent 97.6% from the total generated volume. The total potential RRWH which generated from road surface catchment 13,000 m<sup>3</sup> which represent 2.4% from the total generated volume.
- The volume of potential harvested water in the suitable locations (22 culverts) equal to 189,000 m<sup>3</sup> which represent 36% from the total generated volume. The total potential RRWH which generated from culverts catchment 181,000 m<sup>3</sup> which represent 96 % from the total generated amount.



And the total potential RRWH which generated from road surface catchment  $7,500\text{m}^3$  which represent 4% from the total generated volume.

- Zeedyk, B. (2006), reported that during one road reconstruction project, approximately (3.87 km) of road surface was effectively drained and the runoff is diverted to grassland adjoining the roadway. Thirty drains were installed that will irrigate approximately (0.2024 ha) of grassland per drain and approximately ( $4000\text{m}^3$ ) of water harvested per year going directly to irrigate grassland vegetation.
- There are only 22 culverts locations is suitable for potential water harvesting where there are already WH tanks or there are terraces in the culvert outlet, while there is 18 culverts located either in stream ways, steep slopes or stepped the road alignment.
- The surveyed RRWH along the 10 km are 13 water harvesting structures as two are at executed culverts outlets, two are at the design culverts locations and the remaining are near the road which use the road surface, humps, channels, spillways and a pump to divert and harvest road rainwater.
- The already 5 WH structures at the culverts outlets along the 10 km represent only 22.7% of the potential suitable locations.
- The culverts catchment and outlets type show the different potential locations which vary according to the land use and landscape steepness of the surrounding area, beside land ownership and farmer's attitude
- The culverts catchment could be a sub-catchment, stream line, sub-stream or from the upper road section. While the culvert outlet could be a sub-catchment, stream line, sub-stream, road section, terraces, steep slope and tanks.

- In this case all culverts locations are considered as water harvesting points in the calculation of total RRWH potential in general, while, not all culverts locations is potential for water harvesting. But this can be adapted in some locations such as stream line and sub-catchment outlets and neglected in case of upper road section and steep slopes.
- The other potential RRWH points such as lead out ditches, humps, spillways and channels is not considered in this case study.

- In (case 3).

- The potential rainwater harvesting from the road surface and culvert catchment at station 1400 (case 3) is  $4400 \text{ m}^3$  per year, while the tank capacity is about  $1000 \text{ m}^3$  this will provide supplementary irrigation for about 590 of Qat trees with a total area of  $10,000 \text{ m}^2$ .
- The temporary earthen pond at the culvert station 1400 outlet act as sedimentation and erosion control structure and water harvesting supporting structure.
- The potential RRWH is exceeding the farmer tank capacity and the Qat irrigation requirement which give an opportunity to invest in water harvesting activities such as expand the arable land, increase the tank capacity or build another one.
- The ratio of stored RRWH can be represented by dividing the volume of the tank  $1000 \text{ m}^3$  and the potential harvested water per season (the annual potential harvested water divided by two).
- Social and economic benefits: (1) Increase the farmer income by the increase in Qat yields.(2) Create labor opportunities to alleviate poverty. (3) Provide additional water resources and water storage infrastructure. (4) Avoid the high

cost of buying water from the nearest source by trucks which cost approximately 4600 Y.R for one cubic meter of water.

- Environmental benefits: (1) Reduce the runoff and consequently the road embankment erosion. (2) Maintain the general landscape of the surrounding area. (3) Reduce the road maintenance cost which caused by runoff water.

**Leeson learnt:**

- Considering that one Qat tree need about 300 litres for three supplementary irrigations during the season, then the harvested water in the tank can provide supplementary irrigations for about 3330 Qat trees in a year.
- This case shows clearly that road culvert can supply huge volumes of water for irrigation. And the harvested water in the tank can be stored until it can be used to fulfill the crop water requirement in the following dry season.
- If the stored water is intended to be used for supplementary irrigation for the first growing and yields period, the tank volume can be defined considering the variance in rainfall during the year. (In Yemen there are two main rainy seasons and the total potential RRWH per year can be divided by two). This issue need more future research to define the actual percent of rain in each season.

- In (case 4).

- The potential rainwater harvesting from the road surface and side drainage (case 4) is  $6,200\text{m}^3$  per year, while there is no storage tank and this will provide irrigation for about 145 of coffee trees terraces with a total area of  $2705\text{ m}^2$  .
- The temporary earthen ditch, checks and hump act as diversion and erosion control structure and this should be considered during the road works protection.

- In situ water harvesting techniques and small agriculture pipe or culvert with appropriate protected spillway and side curbs to guide the running water is recommended for this site.
- Social and economic benefits: (1) Increase the coffee yields, (2) create labor opportunities, (3) increase farmer's income.
- Environmental benefits for rainwater harvesting: (1) The erosion control near the terraces and along the road, (2) reduce the potential erosion and gully formation, (3) the accumulated sand may be used as construction material. The harvested water is used for direct irrigation for the coffee terraces using in situ techniques such as terraces bunds and stone mulching.

- In (case 5).

- The ratio of stored RRWH can be represented by dividing the volume of the tank  $1170 \text{ m}^3$  and the potential harvested water per season (the annual potential harvested water divided by two) .
- **Leeson learnt:**

The geometric design plays a key role in the aspect of road rainwater harvesting and the road engineers should take this in the geometric design in a means of profile modification to mitigate the farmer suffer to pump the intercepted water to the tank.
- The possible suggested solutions:
  - A side ditch with reverse slope to the tank will be appropriate with irrigation pipe of 0.5 m in front of the tank sedimentation basin to convey the harvested water from the inner side ditch to the tank. And construct diversion dikes for the left cut section
  - Modification of the vertical profile slope to cope with the RRWH practice.
  - Construct irrigation channel from the culvert to the tank.

- In (case 6).

- The potential rainwater harvesting from the road surface and culvert outlet (case 6) is 3266 m<sup>3</sup> per year, while the pond storage capacity is very small which represent only 9.19 % from the annual potential harvested water.
- The volume of the pond is very small as it represents only 18.37 % from the seasonal potential harvested water 1633 m<sup>3</sup>.
- Social benefits: (1) the pond act as water source for the locals during droughts periods, (2) used to cover water requirement needs where girls and boys use donkeys to convey the water from the pond.
- Environmental benefits: the erosion control at the culvert outlet reduces the potential erosion which occurred in other culverts without any erosion control.

- In (case 7).

- The lesson learnt: Social conflicts and water rights issues should be considered and solved and promises to farmers should be avoided with a clear clarification from the engineers and contractors for the appropriate drainage design.
- Social benefits: the tank is used for water requirement needs and irrigation for some trees near the tank
- Environmental benefits: the erosion control at the culvert out let reduce the potential erosion which occurred in other culverts without any erosion control.

- In (case 8).

- The potential RRWH which generated from the sub road 16 km length is 25,000 m<sup>3</sup>.

- In (case 9).

- The road location on watershed catchment especially the upper catchment need more attention to benefit from the rainwater

- Social benefits: the indigenous way to dig the cisterns should be acknowledged and the cistern built knowledge should be exchange. The dig cistern is used for domestic water requirement and sometimes used to irrigate cash crops during drought periods.
- Environmental benefits: the harvested water provide a water resource for the local inhabitation during droughts periods, the natural / arch roofs minimize the water prone diseases and the evaporation losses. Also the underground locations of the cisterns play a role in the general landscape of the mountainous ridges of the area to maintain and conserve the small areas of arable agriculture terraces.

\* The RRWH structures in the rural mountainous paved road (57) is more comparing to the main road (33) which reflect the effect of road location within the watershed catchment in rainwater harvesting practice.

\* Factors affecting the potential RRWH

In general, the potential RWH depends on characteristics of the catchment; rainfall/runoff ratio; evapotranspiration rates; land use and other human interferences (Van der Gun, et al.,1995). For the roads the potential RRWH depends on the road natural catchment; road surface catchment; road geometric and drainage structures characteristics.

## ***5.2 Stakeholders Results***

- The farmers in the study area suffer from water scarcity and they face it by using different adaptation measures such as convey water from the water sources, from rainwater harvesting, purchase water trucks, harvest rainwater from roofs, rationalize water use, avoid extravagance or share spring water turns, fog harvesting, water saving,

hand wells, and immigrate from their village to another internal place. That means all the above measures are adapted to cope with the water scarcity issues in the study area.

- There are some claims observed during the field interviews about the impact of road construction on water resource such as:

1. The water channels were abandoned and water blockage occurred by the road excavation debris.
2. The road design profile was below the farmlands level which cause difficulty to divert water.
3. The road produces huge floods at some locations that lead to erosion and transmit sediments to farmlands.
4. The use of dynamite in some cut rock sections affect the natural spring line and damages some indigenous old ponds near the explosion location.
5. There is lack of communication between the locals and engineers.

- All farmers consider rainwater running on the road their right. Because water streams ways should remain as they were; it is a well-known right; a property and well known water ways (MARAHEG); , it is father and grandfather MANHAL.

- The main effect of water from roads are: ruin & bury farmlands; disturb & damage water ways; erosion; transmit of sediments and flood accumulation.

- These damages can be mitigated by the following mitigation measures:

1. Using different structures such as (spillways, humps, channels, ponds, sedimentation checks, check walls in water streams, water retention, diversion structures near roads, and check dams to collect water).
2. Oblige the contractor to haulage the excavation debris to allocated locations and maintain water channels & old water ways.

3. Preventing of erosion by making stone paving and protection works for the road sections especially the rural feeder road.
  4. Rehabilitating the agricultural terraces by farmer's.
- Women usually bring the water from the sources to the house and harvest water from roofs beside divert the floods in the case of the absence of the man, thus the RRWH will help the women to save their effort and time consumed in bringing water.

### ***5.3 Roads Engineers Results***

Engineers have practiced a number of possible drainage design procedures and consideration of the general road drainage structures such as culverts, ditches and Irish crossing. The differences in design are often forced by the changes of geology & terrain, experience, use of typical drawings, lack of hydrologic and hydraulic studies, absence of integrated water resource approach, and cost restraint. although some drainage designs are not always economically, socially, environmentally and technically justifiable for rural roads drainage. It is apparent that certain drainage designs are inherently focused on alleviating and shed the runoff from the road surface.

While a number of engineers neglect the RRWH there are an experience and thoughts recorded from the questionnaire such as adaption of gateways in bridges and large culverts to serve the community in a way like spate irrigation mechanism, install agriculture pipes and culverts or use of skew humps to divert water to the farms.

Therefore, an understanding of the integrated road water management and water drainage design can result in a much sustainable and cost effective solution.

- Managing runoff to protect the roadway, prevent erosion and harvest water requires an ability to match road features with landscape features to ensure proper drainage, Zeedyk, B. (2006).



### ***5.4 Geometric and Drainage Design Results***

Almost all Yemen rural roads had adapted design standard to reduce the high construction cost and to sidestep the social conflicts that may occur in case of changing the existing route alignment so the designer try to enhance the existing route and exerted great care in order to avoid any damage to the roads by costly design.

Another challenge is poor quality of design in locally funded projects, there is a considerable difference between the implementation processes used in 100% locally funded projects and those in projects with donor assistance. (road strategy, W.B, 2010). Which noticed through the engineers points of view about the hydrological studies.

- There are a lot of road drainage manuals and almost all of them focus on the main function of the drainage structures which is to evacuate/drain the roads from the running flood water from/crossing the road in appropriate and sufficient way also to maintain a safe crossing for the road users and maintain the surrounding environment. With no specific focus on rainwater harvesting issue which rely on the design and site engineer and supported by budget.

\*From the field visit, road engineer's questionnaire, geometric review and observation of some cases in the main road the following points were observed:

- The road profile not integrated to the RRWH and the farmer constructed humps at raised elevation, also he uses a pump to divert the water to his tank as in case5.
- The farmer's claims of some geometric design problems such as: the road design profile is lower than the farmlands level,
- The culvert location as in case 7 should be reviewed due to current water rights and landownership to avoid social conflicts.

- The contractor and supervision engineer should involve the stakeholders in the construction process in a way of social communication to listen to their problems and try to adopt possible solution with minimum cost as in case 4 by using humps, dry check humps and spillways to reduce erosion and divert water to coffee terraces.

\*Technical and geometric design aspects

- The geometric parameters should be adopted by designers, executive and supervision engineers to cope with the integrated design. Erik Nissen-Petersen - 2006, reported that; all road construction works have no provision for the storage of run-off water generated from road drainage, thus road engineers should be trained and sensitized on the importance of safe disposal of run-off water from roads.
- The number of horizontal curves and sag vertical curves may be used as an indicator for the potential points of RRWH.
- The adaptation includes but not limited to the observed cases in the studied main road such as the:
  - The modification of road profile to gain the running road flood to the harvesting tank and to avoid the pumping of collected water by the earth hump as in case 5.
  - Modification of horizontal alignment in water harvesting location this mean a gentle modification of horizontal curves to be consistent with design standard cross slopes and super elevation to serve the already water harvesting diversions which constructed by farmers in the current dirt road by different ways such as humps, check humps and channels.
  - The ditches slope and outlets designs should focus on the directing the water to the proposed water harvesting locations due to water rights.

**Table 5** Roads structures, functions and their relation to potential rainwater harvesting

<i>No.</i>	<i>Road Structure</i>	<i>sub-structure</i>	<i>Potential Function</i>	<i>Potential Harvesting</i>
1-	Road Surface	Temporary Humps (mud, sand, stones or a piece of cloth)	Intercept and divert surface rainwater in dirt and asphalt roads	Divert and harvest surface rainwater
		Rolling dips	Intercept and divert surface rainwater in rural dirt and stone paved roads	Divert and harvest surface rainwater
		Longitudinal Curbs	Channeled and lead out surface rainwater	Channel, divert and harvest surface rainwater
		Catch basin with under road pipes	Divert surface rainwater	Divert and harvest surface rainwater from inner side to the other side.
2-	Road-side	Embankment	Reduce erosion and retain rainwater	- Plant embankments using half-moon stone bunds (micro-catchment) or other methods.
		Spillways	Control and lead out flow	- Control and direct floods for irrigation, restore or recharge
3-	Side-drains	Ditches	Collect and drain water	- cistern near the ditch with partial blockage - catch basin and pipes to transport water - intake irrigation canals
		Mitre Drain	Lead out ditch flow	- direct irrigation - restore or recharge
		Mini check dams	Reduced (flow speeds / scour) and sand capture	- Sand harvesting
		Catch water drains	Collect water parallel to road alignment	- Irrigation, restore or recharge
4-	Culverts	Outlet	Discharge cross streams and side drain	- direct irrigation or by using canals and flood control structure - restore or recharge to tanks or reservoir
		Inlet	Collect cross streams and side drain	- retain, recharge and flood control by using sluice gate and raise the culvert inlet

**Table 5** Roads structures, functions and their relation to potential rainwater harvesting

<i>No.</i>	<i>Road Structure</i>	<i>sub-structure</i>	<i>Potential Function</i>	<i>Potential Harvesting</i>
5-	Drifts	Fords	Flood control, water spreading or river stabilization.	- retain, recharge, flood control and sand harvesting
		Irish crossing	Flood control, water spreading, river stabilization and sand dams.	- retain, recharge, flood control and sand harvesting
6-	Bridge*	Foundations and columns	Water diversion	Spate irrigation using gates and diversion structures
7-	Roads body*	Road embankment	Retention dams	Reinforced or masonry protected embankments.
		Road drainage structures	Flood control	using sluice gates and raise the culverts inlets
		Road sub-grade and sub-base layers	Control base subsurface flows	Using clever permeable / filter foundation
8-	Borrow pit location and quarries sites		Recharge, storage or retention.	- Recharge, storage or retention ponds. - Rock quarries access small stones may be used to construct terraces with stone mulching

\* star structures are potential structures need more research and integrated design with road construction

## **CHAPTER SIX**

## **CONCLUSION**

## CHAPTER SIX CONCLUSION

### *6.1 Potential RRWH*

- Roads are contributing to solve water scarcity in Yemen, road designer and farmers are playing the role in this issue.
- If the road is geometrically well designed and the farmers have harvested this road rainwater the total RRWH would be 1,700,000 m<sup>3</sup> of rain water
- This water is used for several purposes: drinking, domestic, livestock and agriculture.
- The main road catchment yield is affected by the natural road catchment, the culverts catchments, the road surface geometric properties (profile distances between drainage points, cross slope, super-elevation method, number of horizontal curves which affect the lead out discharge points).
- There is a wide range of small scale road rainwater harvesting structures exists along the road under this study.
- Each defined (suggested) RRWH location in this study is unique and need special technical, social, environmental and cost adoption to cope with integrated design for road and water.
- The RRWH locations were already observed at the culverts outlets, humps, channels, spillways, rolling dips and at the inner side of the road. And it could be at curbs outlets and lead out ditches.
- The RRWH is affected by road location on watershed especially upper/border catchment and affect the attitude of farmers on rainwater harvesting.

## ***6.2 Stakeholders:***

- The farmer's in-field practice and road rainwater harvesting initiatives could be an effective learning and documentation tool to be exchange.
- Farmers used to harvest the flood water from the roads using different techniques or methods such as: temporary humps across the road or rolling dips, channels, side ditches, spillways, cascade steps and culverts.
- Rainwater running on the road were farmer's right as traditional water right.
- There is negative effect of water from/along roads, and some of the mitigation measures are by means of use resilience structures that regulate flood, appropriate road debris haulage and conservation techniques.
- The benefits of RRWH are: water saving, increase production, reduce buying for water and additional source for supplementary irrigation.

## ***6.3 Roads Engineers & geometric design***

- There is a gap in knowledge among roads engineers about the rainwater harvesting from roads.
- There are a number of possible drainage design procedures and considerations for general road drainage structures and often forced by multiple factors.
- More than half of Engineers response used typical drawings from MPWH in drainage structures.
- The water harvesting concept and practice from roads is not recognized by most of the road engineers.
- Some road geometric parameters such as vertical alignments, number of horizontal curves, number of vertical sag curves, camber and (cross-slopes or super-elevation), had effect on road drainage and consequence the rainwater harvesting system.

### ***6.4 Integrated water resource management***

- Road rainwater harvesting is an integrated water resource management tool in means of engaging all stakeholders: farmers, women, road and agriculture engineers, decision makers and donors to upscale the rainwater harvesting. Focusing on water rights, farmer's initiatives, women role, road geometric design and watershed management to protect environment and cope with climate change.



# **CHAPTER SEVEN**

## **RECOMMENDATION**

## **CHAPTER SEVEN RECOMMENDATION**

### ***7.1 RRWH & Stakeholders***

- The RRWH knowledge and experience which had been practiced in different countries should be triggered in road investment in Yemen.
- Farmer's initiatives should be encouraged and improved technically and institutionally, and also should be supported from government's agencies and donor programs.
- The RRWH should be adapted by taking advantage of previous experience locally, regionally and internationally.
- The road and culverts catchment should be compared with the total study area catchment to avoid social conflicts in case of RRWH
- Social communication mechanism between engineers and stakeholders should be developed in all road projects in all phases.
- Detailed road rainwater harvesting balance studies and models should be considered for further research form different background specialist to reach the optimum results.

### ***7.2 Roads Engineers***

- Awareness and training workshops should be arranged for road engineers with hydrologic and watershed specialist.
- Procedures and technical and operational manuals should be prepared for road design, procurement, and supervision beside the integrated RRWH should be in

Arabic and adapted to the conditions in Yemen and reflect best international practices in road rainwater harvesting by different ways and techniques .

- The knowledge gap challenges related the rainwater harvesting from roads, road landscape, watershed, catchment area, community-based water rights and resources, conservation management plans need enhancement and more attention from IWRM approach for roads engineers.
- Technical and operational manuals should be prepared for integrated road and water management design and implementation.

### ***7.3 Geometric Design***

- A Careful consideration of coordination and combination the horizontal and vertical alignments and drainage structures with reference to road catchment and natural drainage pattern which may be best indicated by:
  1. Contoured drawings of the required carriageway surface with water stream lines, culverts locations, land use map and potential RRWH locations to serve the road rainwater harvesting facilities.
  2. Details drawings of drainage structures (culverts, ditches, etc..) plan and profile especially when the cross section changed from cut to fill and at the outlet.
- Staged co-financed integrated approach (design and implementation) is suggested to cope with the cost factor (taking advantage of road construction equipment's) to achieve the sustainable rainwater harvesting in the road vicinity.
- MPWH typical drawing should be updated and reviewed according to Yemen Hydrologic studies and RRWH integrated approach.

- Road drainage structures and protection works in the main road section should take in consideration the integrated design for water harvesting, water rights, erosion control, environment sustainability and social and gender expectations.
- Routine road maintenance activities should consider the social involvement in some activities as community participation during maintenance.

### ***7.4 Up scaling RRWH***

1. The prevailing road drainage structures located along the mountainous roads are of potential problems in roads design and construction leading to an increase in costs, and extensive maintenance program.
2. There are a lot of techniques and considerations for RRWH and this need an integrated approach with technical standards and socio-economic and environment issues between related stakeholders, engineers, contractors, decision makers, governments parties, donors, institutions, NGO, and farmers.
3. The storing and retention facilities can be tanks, cisterns, trenches, infiltration basins, wetlands, ponds, borrow pit excavation locations or direct irrigation.

For Up scaling RRWH some activities can be triggered in road industry such as :

1. Establish some rainwater harvesting techniques along roads by appropriate execution method (community contracting or cash for water harvesting)
2. Involve road stakeholders in maintenance of road drainage structures or watershed management works which only need man power and based on performance and period contracts.
3. Encourage the investment in planting new cash trees (such as almond and coffee) along road side which depend mainly on seasonal rainfall for irrigation with some extra complementary irrigation that can be maintained by construct

rainwater harvesting tanks or by soil moisture conservation techniques like terraces and stone mulching using local quarry material.

The outcome of up scaling the roads rainwater harvesting are as follows:

1. Enhance the watershed management,
2. Reduce the road maintenance cost due to the project raised efficiency of drainage structures.
3. Raise the water availability.
4. Protect the environment and conserve soil from degradation and erosion.
5. Encourage the agriculture of cash crops/trees to alleviate poverty.

### ***7.5 Further research***

- 1- Models of roads geometrics and catchments runoff coefficient & rainfall runoff relation with the detailed rainfall day by day data should be conducted to determine the potential RRWH.
- 2- Climate change impact and adaptation measures should be study along the road rainwater harvesting structures.
- 3- Models of the exact harvested water volume for each rainy season should be studied to define the potential rainwater volume for water harvesting structures.

# **REFERENCES**

## REFERENCES

### 8. References

- AASHTO, 2001, (A Policy in Geometric Design of Highway and Streets), fourth edition, American Association of State Highway Transportation Officials, 444 North Capitol Street N.W., Suite 249. Washington D.C.20001.
- Al-Asbahi, Q. Y. (2005). Water Resources Information in Yemen. IWG-Env, International Work Session on Water Statistics, (pp. 1-12). Vienna .
- Agricultural Statistics Year Book (MAI, 2000a) by Ali Abdulmalek Alabsi, FAO, 2006)
- Ben Kubbinga, 2012, Master Thesis on Road Runoff Harvesting in the Dry lands of Sub-Saharan Africa, Its Potential for Assisting Smallholder Farmers in Coping with Water Scarcity and Climate Change, Based on Case Studies in Eastern Province, Kenya (A Thesis Submitted to The Institute of Environmental Sciences in Partial Fulfillment of The Requirements for The Degree of Master in Science in Environment and Resource Management (Specialisation Biodiversity and Ecosystem Services))
- Diego Garcia-Landarte Puertas, et al. (2014), Roads for water: the unused potential
- DiPiazza, Francesca Davis. . (2008). Yemen in Pictures. . Minneapolis: Lerner Publishing Group.
- DMRB, H. 1. (2004). Design Manual For Roads And Bridges. In HA 106: Drainage of Runoff from Natural Catchment (Vols. Volume 4 Section 2, Part 1).
- (DMRB, HD 33/06, (Surface and Sub-Surface Drainage Systems for Highway), May 2006),.
- TD 9 (DMRB 6.1.1)
- (TD 16 (DMRB 6.2.3))
- Census, 2004
- Encyclopædia Britannica Online. —Arabia Felix. (2010). Retrieved from <http://search.eb.com/eb/article-9008151>
- Falkenmark, M., Rockström, J. Rain: The Neglected Resource. Swedish Water House Policy Brief Nr. 2. SIWI, 2005. [www.swedishwaterhouse.se](http://www.swedishwaterhouse.se) or [www.sivi.org](http://www.sivi.org).
- Frank van Steenbergen (MetaMeta), Mohamed Al-Abyadh, M. (Road Maintenance Fund, Ministry of Public Works and Highways, Government of

- Yemen) and Sharaffadin Salah (Water and Environment Centre, Sana'a University) with contributions of Kifle Woldeageray. 2014. Water from Roads in Yemen: A Guidance Note, Visit [www.roadsforwater.org/](http://www.roadsforwater.org/)
- Glass, N. (June 2010). The Water Crisis in Yemen: Causes, Consequences and Solutions. Global Majority E-Journal, Vol. 1, No.1 , pp. 17-30.
  - HADDEN, R. L. (2012). The Geology of Yemen: An Annotated Bibliography of Yemen's Geology, Geography and Earth Science. Alexandria, Virginia: Army Geospatial Center.
  - Ismail, S. (2009, August 26). <http://reliefweb.int/report/yemen/drought-and-floods-yemen-affect-food-security>. Retrieved from <http://reliefweb.int/report/yemen/drought-and-floods-yemen-affect-food-security>
  - IWG-Env, International Work Session on Water Statistics, Vienna, June 20-22 2005 By Qahtan Yehya A.M. Al-Asbahi -National Integrated Water Resources Management Program – Yemen
  - Johannessen, Bjørn, Building rural roads / Bjørn Johannessen. - Bangkok: ILO, 2008
  - 466 p. ISBN: 9789221209775; 9789221209782 (web pdf) International Labour Organization; ILO Regional Office for Asia and the Pacific; ILO ASIST Asia Pacific road construction / rural public works / labour intensive employment / rural employment / q alleviation 10.05.6 / ILO Cataloguing in Publication Data
  - Kasinof, L. (2009, November 5). The Christian Science Monitor. Retrieved from At Heart of Yemen's Conflicts: Water Crisis.: <http://www.csmonitor.com/World/Middle-East/2009/1105/p06s13-wome.html>
  - Kasperek Verlag, M. (2007). Yemen: Haraz Mountains: Nature, Culture, Trekking. Heidelberg,Germany: Yemen General Tourism Development Authority. (Printed)
  - Kithinji Mutunga and Will Critchley with P. Lameck, A. Lwakuba and C. Mburu, 2001. Farmers' Initiatives In Land Husbandry - Promising technologies for\ the drier areas of East Africa by – Published in partnership between: UNDP – Office to Combat Desertification and Drought (UNSO/ESDG/BDP) and Sida's Regional Land Management Unit, 2001
  - (Mutunga and Critchley, 2001)
  - Kifle Woldearegay, Frank van Steenbergen, Marta Agujetas Perez, Berhane Grum, Martin van Beusekom, Paper title : ( Water harvesting from roads: climate resilience in Tigray, Ethiopia) submitted to: IRF Europe & Central Asia Regional Congress September 15-18, 2015 – Istanbul Turkey
  - Knoop L., Sambalino F. , and F. Van Steenbergen. (2012). Securing Water and Land in the Tana Basin:a resource book for water managers and practitioners. (S. F. Knoop L., Ed.) Wageningen, The Netherlands.



- Lichtenthaeler, Gerhard, 2014, MER254, "Water Conflict and Cooperation in Yemen"
- Mekdaschi Studer, R. and Liniger, H. 2013. Water Harvesting: Guidelines to Good Practice. Centre for Development and Environment (CDE), Bern; Rainwater Harvesting Implementation Network (RAIN), Amsterdam; MetaMeta, Wageningen; The International Fund for Agricultural Development (IFAD), Rome.
- Meseret Dawit Teweldebrhan ,2014, Master of Science Thesis on Optimizing Intensified Runoff from Roads for Supplemental Irrigation: Tigray Region, Ethiopia, Submitted to UNESCO-IHE Institute for Water Education, Delft, the Netherlands
- Ministry of Public Works and Highways, Yemen, Road Sector Report, 2009.
- Ministry of Public Works and Highways, Yemen, Rural Access Program (RAP), Design Manual (RAPDM), 2009.
- Ministry of Public Works and Highway, Road Maintenance Fund, Preliminary Design Report, October 2010, Volume I: Report, Feasibility Study and Detailed Engineering Design for Sana'a Al-Hodiedah Road.
- Ministry of Public Works and Highway, Road Maintenance Fund, Annual Report, 2013.
- Ministry of Public Works and Highway, GCRB, Hydrological Manual for Yemen, Annexes
- Ministry of Oil and Minerals Resources
- Nissen-Petersen, e. (2006) Water from Roads: A Handbook for Technicians and Farmers on Harvesting Rain Water from Roads, nairobi: ASAL consultants ltd. [http://www.samsamwater.com/library/Book6\\_Water\\_from\\_roads.pdf](http://www.samsamwater.com/library/Book6_Water_from_roads.pdf)
- NAPA. (2010). National Adaptation Programme of Action (NAPA). Sana'a : Republic of Yemen, Environment Protection Authority .
- Nathan Wendt and Laith Aqel. ( 2012, June 26). Yemen's Water Crisis: The Urgent Need. Retrieved May 20, 2013, from Published on EastWest Institute: (<http://www.ewi.info>)
- Nama'a NGO papers 2013
- Ngigi, S.N., 2003. Rainwater Harvesting for Improved Food Security: Promising Technologies
- in the Greater Horn of Africa, Greater Horn of Africa Rainwater Partnership (GHARP) and
- Kenya Rainwater Association (KRA), Nairobi, Kenya.

- Oweis, Theib; Ahmed Hachum and Adriana Bruggeman. (eds). 2004. Indigenous Water Harvesting Systems in West Asia and North Africa. ICARDA, Aleppo, Syria, vi+ 173 pp. En.
- (PIP) Public Investment Program for 2007-2010, 2006, Republic Of Yemen, Consultative Group Meeting, London, November 15 – 16, 2006, Ministry of Planning and International Cooperation
- SamSamWater Climate Tool
- Shukri and Basta, 1955
- Steenbergen, F. van (MetaMeta); Woldearegay, K. (Mekelle Univeristy).; Beusekom, H.M.van (MetaMeta Circular Economy); Garcia Landarte, D. (MetaMeta Ethiopia) and Al-Abyadh, M.(Road Maintenance Fund, Ministry of Infrastructure and Highways, Government of Yemen). 2014. How to do Roads for Water – IFAD. Visit [www.roadsforwater.org/](http://www.roadsforwater.org/)
- Tsunokawa, Koji; Hoban, Christopher [editors]. 1997. Roads and the environment : a handbook. World Bank technical paper ; no. WTP 376. Washington, D.C. : The World Bank. <http://documents.worldbank.org/curated/en/1997/11/693949/roads-environment-handbook>
- UNDP, 2013 – Water Governance Program for Arab States (WGP-AS), National Foundation for Watershed Management- Republic of Yemen, Manakha Rainwater and Fog Harvesting Project, Final Report (Dec.2013). Retrieved from <http://www.undp.org/content/dam/yemen/E&E/Docs/UNDP-YEMManakha%20Project%20.%20final%20report%20.pdf>
- Van der Gun, (1995). The water resources of Yemen, Report WRY35. Delft, The Netherland: TNO.
- Wenner, \. w. (1991). The Yemen Arab Republic: Development and Change in an Ancient Land. . Boulder, CO: Westview Press. .
- Wheeler, H. S. (2004). Indigenous Water Harvesting Systems in West Asia and North Africa. Indigenous Water Harvesting Systems in West Asia and North Africa. (p. 173). Aleppo, Syria: ICARDA.
- W.B, I. (Sept 2009). Reducing Serious Water Stress . World Bank .
- World Bank. 2010. Yemen, Republic of - Road sector strategy note. Washington, DC: World Bank. <http://documents.worldbank.org/curated/en/2010/08/14106629/yemen-republic-road-sector-strategy-note>
- World Bank. 2013. The Little Green Data Book 2013. Washington, DC: World Bank.doi: 10.1596/978-0-8213-9814-2. License: Creative Commons Attribution CC BY 3.0

- Zeedyk, B. (2006) A Good Road Lies Easy on the Land... Water Harvesting from Low-Standard Rural Roads [pdf] Santa Fe: The Quivira Coalition, Zeedyk Ecological Consulting, LLC, The Rio Puerco Management Committee – Watershed Initiative, and the New Mexico Environment Department – Surface Water Quality Bureau <[http://quiviracoalition.org/images/pdfs/1888-A\\_Good\\_Road\\_Lies\\_Easy\\_on\\_the\\_Land.pdf](http://quiviracoalition.org/images/pdfs/1888-A_Good_Road_Lies_Easy_on_the_Land.pdf)>

# **ANNEXES**

**(Annex 1) Farmers' semi-structured questionnaire**

Water and  
Environment Centre

Sana'a University – Water & Environment Center

مركز المياه والبيئة – جامعة صنعاء

Farmers Questionnaire for Master Thesis in Water harvesting from Roads, A case study of Maghrabah Manakah - Bab Bahil Road and the linked rural road Jabal Ekbari and Jabal Awi Road, Manakah District , Sana'a Governorat

جامعة صنعاء

دراسة حالة لطريق مغربية مناخة – باب باحل مع الطريق الريفي الرابط بين جبل عكباري – جبل العوي – مديرية مناخة - محافظة صنعاء )

Code	Basic Information معلومات عامة	
	Question	Answer
VarB1	Village القرية	
VarB2	Road name and construction year إسم الطريق و سنة إنشاء الطريق	
VarB3	<u>Road Point Location</u>	East : _____ North : _____ Elevation : _____
VarB4	Name الاسم	
VarB5	Age العمر	
VarB6	Current job الوظيفة الحالية	
VarB7	Years of working in agriculture سنوات العمل في الزراعة	
VarB8	Level of Education المستوى التعليمي	
VarB9		



Water and  
Environment Centre

Sana'a University – Water & Environment Center

جامعة صنعاء – مركز المياه والبيئة

Farmers Questionnaire for Master Thesis in Water harvesting from Roads, A case study of Maghrabah Manakah - Bab Bahil Road and the linked rural road Jabal Ekbari and Jabal Awi Road, Manakah District , Sana'a Governorate

إستبيان للمزارعين ( لبحث ماجستير عن حصاد مياه الأمطار من الطرق – دراسة حالة لطريق مغربة مناخة – باب باحل مع الطريق الريفي الرابط بين جبل عكباري – جبل العوي – مديرية مناخة - محافظة صنعاء )

Code		
	Question	Answer
	<b>Water Resource, Water Scarcity and Climate Change</b>	
Var1	What are the water resources in your area? ماهي مصادر المياه في منطقتك؟	<p>أمطار      Rain</p> <p>آبار      Wells</p> <p>شبكة مياه      Water Network</p> <p>أخرى      Other</p>
	Do you face water scarcity? And how you face it? هل تعاني من شحة في المياه؟ وكيف يتم مواجهتها؟	
	What are the risks you faced due to climate change? ما هي المخاطر التي تواجهها نتيجة التغير المناخي؟	
	Does there any change in rain season period, for example before ten years and now? How? هل هناك أي تغير في مواسم الأمطار، على سبيل المثال قبل عشر سنوات والآن؟ أوصف ذلك؟	
Var5		



إستبيان للمزارعين ( لبحث ماجستير عن حصاد مياه الأمطار من الطرق – دراسة حالة لطريق مغربية مناخة – باب باحل مع الطريق الريفي الرابط بين جبل عكباري – جبل العوي – مديرية مناخة - محافظة صنعاء )

Code				Comment ملاحظة
	<b>Roads &amp; Water Harvesting</b>			
Var6	<p><b>Do you have Land adjacent to the road side?</b></p> <p>هل لديك أرض. زراعة قريبة من جانبي الطريق؟</p>	Yes نعم		NO لا
Var7	<p><b>Do you use the water floods running from/on road</b></p> <p>هل تستخدم مياه السيول من أو على الطرق</p>	Yes نعم		NO لا
Var7-a	<p><b>If Yes, how you used to do so :</b></p> <p>A- from Side Ditches ( outlet – temporary checks)</p> <p>B- Across the road by temporary hump.</p> <p>C- From Culverts</p> <p>D- From Water Harvesting Structure by the road side</p> <p>E- Spill way outlet</p> <p>F- Other</p> <p>.....</p> <p>.....</p> <p>.....</p> <p>.....</p> <p>.....</p>	<p>إذا كانت الإجابة نعم ..كيف تعودت على حصاده:</p> <p>أ – من القنوات الجانبية ( المخارج – حواجز مؤقتة )</p> <p>ب – من سطح الطريق باستخدام مطبات مؤقتة .</p> <p>ج – من العبارات .</p> <p>د- من منشآت حصاد مياه على جانبي الطريق</p> <p>هـ - مخارج (مدارب) مياه.</p> <p>و- غيرها .....</p> <p>.....</p> <p>.....</p> <p>.....</p> <p>.....</p>		↑
Var7-a1	<p><b>If Yes, What is the harvesting structure do you have and how much the volume of storage water?</b></p> <p>إذا كانت الإجابة نعم ما هي منشأة الحصاد التي لديك وكم حجم المياه التي تحصد ؟</p>			
Var7-b	<p><b>If Yes , which way do you use it :</b></p> <p>A- For drinking</p> <p>B- For agriculture</p> <p>C- For domestic use</p> <p>D- For Supplementary irrigation</p> <p>E- Other</p> <p>.....</p> <p>.....</p> <p>.....</p>	<p>إذا كانت الإجابة نعم ...ما هي الأغراض التي يتم استخدامه فيها :</p> <p>أ – للشرب.</p> <p>ب – للزراعة.</p> <p>ج – للاستخدام المنزلي .</p> <p>د - للري التكميلي .</p> <p>هـ - غيرها .....</p> <p>.....</p> <p>.....</p>		



Water and  
Environment Centre

Sana'a University – Water & Environment Center

جامعة صنعاء – مركز المياه والبيئة

Farmers Questionnaire for Master Thesis in Water harvesting from Roads, A case study of Maghrabah Manakah - Bab Bahil Road and the linked rural road Jabal Ekbari and Jabal Awi Road, Manakah District , Sana'a Governorate

إستبيان للمزارعين ( لبحث ماجستير عن حصاد مياه الأمطار من الطرق – دراسة حالة لطريق مغربية مناخة – باب باحل مع الطريق الريفي الرابط بين جبل عكباري – جبل العوي – مديرية مناخة - محافظة صنعاء )

Code			Comment ملاحظة
	..... ..... .....		
Var7-b1	<b>If you use it for agriculture, which crops or tree you plant?</b> إذا كنت تستخدمها للزراعة: ما هي المحاصيل الزراعية أو الأشجار التي تقوم بزراعتها.		
Var7-c	<b>If Not , why you don't use the water floods running from/on roads ?</b> إذا كانت الإجابة لا.. لماذا لا تستخدم مياه السيول المتدفقة على ومن الطرق؟		
<b>Water Benefits</b>			
Var8	<b>What are the benefits of reuse of additional captured water from roads?</b> - water storage - increase production - reduce buying water - other ... mention	ما هي الفوائد من إعادة استخدام المياه المحصودة من الطرق ؟  - توفير المياه - زيادة الإنتاجية - التقليل من شراء الماء - غير ذلك... يذكر.	
<b>Water Rights</b>			
Var9	<b>Do you consider water floods running from/on roads your right?</b> هل تعتبر مياه السيول المتدفقة على ومن الطرق حق من حقوقك		
Var10	<b>What is your experience in water rights from roads ? and how can it be developed throw road design ?</b> ماهي خبرتك في مجال حقوق المياه من الطريق وكيف يمكن تطويرها من خلال تصميم الطريق		





Water and  
Environment Centre

Sana'a University – Water & Environment Center

جامعة صنعاء – مركز المياه والبيئة

Farmers Questionnaire for Master Thesis in Water harvesting from Roads, A case study of Maghrabah Manakah - Bab Bahil Road and the linked rural road Jabal Ekbari and Jabal Awi Road, Manakah District , Sana'a Governorate

إستبيان للمزارعين ( لبحث ماجستير عن حصاد مياه الأمطار من الطرق – دراسة حالة لطريق مغربة مناخة – باب باحل مع الطريق الريفي الرابط بين جبل عكباري – جبل العوي – مديرية مناخة - محافظة صنعاء )

Code			Comment ملاحظة
Var11	Does the road change the water ways pattern? هل الطريق يغير من مسارات المياه التقليدية أو الأصلية ( المساقى والمدارب الطبيعية)؟		
Var11-a	If yes, what are the main problems prevent the flood water to reach the farmers and what is the solution – Mention some locations as a case from site? إذا كانت الإجابة نعم ، ماهي أهم المشاكل التي تعوق وصول المياه الى المزارعين وماهي الحلول ، استعن ببعض المواقع في اجابتك كحالته من الواقع ؟		
<b>Water &amp; Road Effects to the Landscape</b>			
Var13	What are the damages caused by water from/on roads? ما هي الأضرار التي تتسبب بها المياه من الطرق او عليه ؟		
Var14	In your opinion how can we mitigate or avoid this damage? في رأيك .. كيف يمكن تخفيف أو منع هذه الأضرار ؟		
<b>Water Quality</b>			
Var15	Do you think the water from/on road is contaminated? هل تعتقد أن المياه من الطرق ملوثة ؟	Yes نعم	NO لا
Var15-a	If Yes ,what do you think is the source of contamination A- Residual Oil in the road B- Other	إذا كانت الإجابة نعم ،في اعتقادك ما هي مصادر التلوث : أ – الزيوت العالقة على سطح الطرق. ب – غيرها	
Var15-b	If Yes, what do you do to solve this problem? إذا كانت الإجابة نعم كيف يتم حل هذه المشكلة ؟		



Water and  
Environment Centre

Sana'a University – Water & Environment Center

جامعة صنعاء – مركز المياه والبيئة

Farmers Questionnaire for Master Thesis in Water harvesting from Roads, A case study of Maghrabah Manakah - Bab Bahil Road and the linked rural road Jabal Ekbari and Jabal Awi Road, Manakah District , Sana'a Governorate

إستبيان للمزارعين ( لبحث ماجستير عن حصاد مياه الأمطار من الطرق – دراسة حالة لطريق مغربية مناخة – باب باحل مع الطريق الريفى الرابط بين جبل عكباري – جبل العوي – مديرية مناخة - محافظة صنعاء )

Code			Comment ملاحظة
Var 16	<p><b>Do you use any techniques to purify water? How?</b></p> <p>هل تستخدم أي تقنية لتقية المياه؟ كيف؟</p>		
<b>Women Rules</b>			
Var 17	<p><b>What is the rule of women in water in general and in water harvesting?</b></p> <p>ما هو دور المرأة بشكل عام في مصادر المياه ودورها في حصاد المياه؟</p>		
Var18	<p><b>Does the RRH contribute and help women participation in agriculture and households works?</b></p>	هل ساهم توفير حصاد المياه من الطرق في تخفيف عبء المرأة في أعمال الزراعة والأعمال المنزلية .	
<b>Recommendation and Ambition</b>			
Var19	<p><b>What is you recommendation and your ambition for the future?</b></p> <p>ما هي توصياتك وطموحاتك للمستقبل؟</p>		

*(Annex 2) Engineers' questionnaire***Technical Questionnaire for Road Engineers (water and rural roads)**

إستبيان فني لمهندسي الطرق حول المياه والطرق الريفية

Code	Basic Information معلومات عامة	
	Question	Answer
Var.1	Name الإسم	
Var.2	Age العمر	
Var.3	Years of General Experience سنوات الخبرة العامة	
Var.4	Years of Road Design Experience سنوات الخبرة في تصميم الطرق	
Var.5	Years of Road Supervision Experience سنوات الخبرة في الإشراف على الطرق	
Var.6	Current job الوظيفة الحالية	Var.6.a Main الأساسية : Var.6.b Consultant الإستشاريه :
Var.7	Current authority of work : جهة العمل الحالية	Var.7.a Main : Var.7.b Consultant :
Var.8	Educational Level المستوى التعليمي	Var.8.a PhD Degree دكتوراه Var.8.b Master Degree ماجستير Var.8.c Bsc. Degree باكلاوريوس
Var.9	Mobile No. & E-mail Address رقم الجوال والبريد الإلكتروني	

Code	Generals عام	
Var.G1	What standards or design manuals do you use in geometric road designs? ما هي المقاييس أو أدلة التصميم التي تستخدم للتصميم الهندسي للطرق	Mention it إذكرها
Var.G2	What Programs or commercially available software's do you use for road design? ما هي البرامج الهندسية التي تستخدم لتصميم الطرق	Mention it إذكرها
Var.G3	What standard methods or commercially available software's do you use for road drainage design? ما هي المقاييس أو البرامج الهندسية التي تستخدم لتصميم منشآت تصريف المياه في الطرق	Mention it إذكرها

Code	Generals عام	
Var.G4	<p>What is your experience about the effect of roads on water harvesting from roads? Describe examples if possible...</p> <p>ما هي خبرتك حول تأثير الطرق على حصاد المياه من الطرق؟ أذكر أمثلة إذا أمكن ...</p>	Mention it إنكرها
Var.G4	<p>Is it possible to use roads construction for ground water recharge? If Yes describe how?</p> <p>هل يمكن الاستفادة من إنشاء الطرق لتغذية المياه الجوفية؟ إذا نعم أوصف كيف؟</p>	

Code	Culverts العبارات	
Var.C1	<p>How do you choose the location of culverts in road projects</p> <p>كيف يتم تحديد مواقع العبارات في مشاريع الطرق</p>	A. Due to water ways and streams cross the road في مجاري المياه والمشارب المتقاطعة مع الطريق
		B. Due to detailed hydrologic study بموجب دراسة هيدرولوجية تفصيلية
		C. At every vertical sag curve عند كل منحنى رأسي مقعر
		D. At equal intervals على مسافات متساوية
		E. Others ...Mention it أخرى ..... تذكر ..... .....
Var.C2	<p>How do you define the type of culverts in road projects</p> <p>كيف يتم تحديد نوع العبارات في مشاريع الطرق</p>	A. Due to technical standards طبقا للمواصفات الفنية
		B. Due to detailed hydrologic study بموجب دراسة هيدرولوجية تفصيلية
		C. Due to typical designs from MPWH and the experience of the consultant to choose from it. بموجب نماذج معتمدة من وزارة الأشغال العامة والطرق وخبرة المهندس الاستشاري لتحديد النوع المناسب.
		D. Due to cost analysis alternative for the available materials in the project location بموجب تحليل سعري للبدائل المتوفرة للمواد في موقع المشروع
		E. Others ...Mention it أخرى ..... تذكر ..... .....
Var.C3	<p>How do you define the size of culverts in road projects</p> <p>كيف يتم تحديد ابعاد العبارات في مشاريع الطرق</p>	A. Due to detailed hydrologic study بموجب دراسة هيدرولوجية تفصيلية
		B. Due to the noticed width and height of the stream line بموجب مشاهدته عرض وإرتفاع المجرى المائي
		C. Others ...Mention it أخرى ..... تذكر ..... .....

Code	العبارات Culverts		
Var.C4	<p>How do you design the Inlets of the culvert</p> <p>كيف يتم تصميم مداخل العبارات في مشاريع الطرق</p>		<p>A. Due to detailed hydrologic study بموجب دراسة هيدرولوجية تفصيلية</p>
			<p>B. Due to typical drawings and according to the inlet type in cut or fill section بموجب نماذج وبحسب طبيعة المدخل في القطع أو الردم</p>
			<p>C. Due to in site structural designs as needed بموجب تصاميم يتم عملها في الموقع بحسب الاحتياج</p>
			<p>D. Others ...Mention it اخرى..... تذكر ..... .....</p>
Var.C5	<p>Does the scour depth been calculated? And does the transmitted sedimentation considered in sediment basin design before the Inlet and water velocity and the effect of it to the surrounding land at the outlet?</p>		
Var.C6	<p>How do you design the Outlets of the culvert</p> <p>كيف يتم تصميم مخارج العبارات في مشاريع الطرق</p>		<p>A. Due to detailed hydrologic study بموجب دراسة هيدرولوجية تفصيلية</p>
			<p>B. Due to typical drawings and according to the outlet type بموجب نماذج وبحسب طبيعة المخرج</p>
			<p>C. Due to in site structural designs as needed بموجب تصاميم يتم عملها في الموقع بحسب الاحتياج</p>
			<p>D. Others ...Mention it اخرى..... تذكر .....</p>
Var.C7A	<p>How do you design the Spill-Way at the culvert outlet? كيف يتم تصميم مجرى الماء في مخرج العبارة؟</p>		
Var.C7B	<p>Does water harvesting or irrigation or groundwater recharge from the culvert outlet considered? If Yes how? هل يؤخذ إعتبار لحصاد مياه الأمطار أو الري أو التغذية الجوفية من مخرج العبارة؟ إذا كانت الإجابة نعم كيف يتم ذلك؟</p>		
Var.C8			

Code	القنوات الجانبية وتصريف المياه على جوانب الطريق Ditches and Road side drainage	
Var.D1	How do you define the dimension and shape of side Ditches in road projects  كيف يتم تحديد ابعاد وشكل الدتشات الجانبية في مشاريع الطرق	A. Due to typical designs from MPWH and the experience of the consultant to choose from it. بموجب نماذج معتمدة من وزارة الأشغال العامة والطرق وخبرة المهندس الاستشاري لتحديد النوع المناسب.
		B. Due to detailed hydrologic study بموجب دراسة هيدرولوجية تفصيلية
		C. Due to an offset distance from the asphalt edge to the cut side بموجب مسافة ثابتة موازية لحافة الأسفلت وإلى حافة القطع الخارجي
		D. Others ...Mention it أخرى ..... تذكر ..... .....
Var.D2	How do you define the longitudinal slope of ditches in road projects  كيف يتم تحديد الميول الطولية للدتشات في مشاريع الطرق	A. Due to technical standards طبقاً للمواصفات الفنية
		B. Due to detailed hydrologic study بموجب دراسة هيدرولوجية تفصيلية
		C. Due to typical designs from MPWH and the experience of the consultant to choose from it. بموجب نماذج معتمدة من وزارة الأشغال العامة والطرق وخبرة المهندس الاستشاري لتحديد النوع المناسب.
		D. Parallel to the slope of the main asphalt profile with a drop of the ditch depth موازي لميل المنحنى الرأسي للأسفلت مع وجود فارق منسوب يتمثل في عمق القناة الجانبية
		E. Others ...Mention it أخرى ..... تذكر ..... .....
Var.D3	How do you define the exit of the side ditches  كيف يتم تحديد مخارج الدتشات الجانبية	A. At the end of every horizontal curve في نهاية كل منحنى أفقي
		B. Following the natural water ways by using culverts or irrigation pipes to divert water. اتباع مجاري المياه الطبيعية باستخدام العبارات أو الأنابيب الزراعية لتحويل المياه.
		C. Others ...Mention it أخرى ..... تذكر ..... .....
Var.D4	How do you choose the type of the ditches ( Riprap – Concrete – Earthen)  كيف يتم اختيار نوع القنوات الجانبية (ريراب – خرسانة – ترابية)	A. Due to detailed hydro geologic study بموجب دراسة هيدروجيولوجية تفصيلية
		B. Due to typical drawings and according to X-section type in cut or fill بموجب نماذج وبحسب طبيعة المقطع القطع أو الردم
		C. Due to in site structural designs as needed بموجب تصاميم يتم عملها في الموقع بحسب الاحتياج
		D. Others ...Mention it أخرى ..... تذكر ..... .....

Code	القنوات الجانبية وتصريف المياه على جوانب الطريق Ditches and Road side drainage		
Var.D5	Does the scour depth been calculated in spillways? And how ?	Yes No	هل يتم حساب عمق النحر في المسارب ؟ وكيف يتم حسابه ؟ .....
Var.D6	Do you use curbs at road sides? And how did you defined the outlet ?	Yes No	هل يتم استخدام بردورات في جوانب الطريق ؟ وكيف يتم تحديد المخرج ؟
Var.D7	What other road side drainage structures you used?		ما هي منشآت التصريف الجانبية الأخرى للطريق التي تستخدمها ؟
Var.D8	Does water harvesting or irrigation or groundwater recharge from road side drainage structures considered? If Yes how?		هل يؤخذ إعتبار لحصاد مياه الأمطار أو الري أو التغذية الجوفية من منشآت التصريف الجانبية ؟ إذا كانت الإجابة نعم كيف يتم ذلك ؟
Var.D9	Specific Observations on ditches and road sides drainage structure design and problems from your point of view...		
	هل لديك ملاحظات محددة على الدتشات أو تصميم منشآت التصريف الجانبي وما هي المشاكل من وجهة نظرك		

Code	الجسور السطحية Irish Crossing		
Var.I1	How do you design the Irish Crossing structure كيف يتم تصميم منشآت الجسور السطحية		ذكرها Mention it
Var.I2			
Var.I3			
Var.I4			
Var.I5	Specific Observations on Irish crossing structure design and problems from your point of view...		
	هل لديك ملاحظات محددة على الجسور السطحية وما هي المشاكل من وجهة نظرك		

الزملاء الأعضاء في حال توفر لديكم أي توثيق بالصور عن أضرار المياه على الطرق أو حصاد مياه الأمطار من الطرق يرجى إرسالها  
 أما للبريد الإلكتروني [mabyadh@yahoo.com](mailto:mabyadh@yahoo.com)  
 أو حساب الفيس بوك على الرابط <https://www.facebook.com/mohammed.alabyadh>  
 أو عبر برامج الهواتف الذكية على الرقم 00967-777717282 ....

**Annex 3 Main road rianwater harvesting structures**

No	North	East	Description	Water Harvesting Technique
1	15.10399	43.73586	Roofed Tank with Single Skin panels	Culvert and road surface
2	15.108132	43.736495	Open Tank near Qat terraces at 1400	Culvert outlet 1400
3	15.108112	43.736674	Open Tank	Road surface hump
4	15.1137	43.72948	Open Tank Bait Shaibah 2+650	Road surface hump and pump
5	15.11627	43.72758	Open Tank Near culvert outlet 3+025	Culvert outlet
6	15.127	43.71573	Roofed Tank with old corrugated zinc panels	Road surface
7	15.1277	43.71516	Open Tank SFD Bani Khatab	Road surface and external catchment
8	15.12802	43.71573	Roofed Cistern	Channel from road and external catchment
9	15.12804	43.71559	Under excavation cistern	Channel from road and external catchment
10	15.12836	43.71539	Open Tank small	Road surface and terraces
11	15.13125	43.71713	Under excavation Tank	Road surface and terraces
12	15.1351	43.71673	Open Tank Ghial near coffee terraces	Road surface & external catchment (terraces)
13	15.1562	43.71875	Roofed Tank with wood shrubs	Road surface by earthen canal
14	15.15668	43.71788	Roofed Tank with old corrugated zinc panels	
15	15.16719	43.71644	Roofed Tank with old corrugated zinc panels	
16	15.16848	43.71486	Roofed Tank with old corrugated zinc panels	
17	15.16844	43.71475	Roofed Tank with Single Skin panels	
18	15.16874	43.71462	Roofed Tank with Single Skin panels	
19	15.16972	43.7141	Roofed Tank with Single Skin panels	
20	15.16993	43.71418	Roofed Tank with Single Skin panels	
21	15.17054	43.71468	Roofed Tank with Single Skin panels	
22	15.17054	43.7144	Open Tank small	



No	North	East	Description	Water Harvesting Technique
23	15.17201	43.71387	Roofed Tank old corrugated zinc panels	
24	15.19168	43.69729	Under excavation Tank Hoaid	Road surface
25	15.19194	43.68279	Roofed Tank with corrugated zinc panels	
26	15.19158	43.68288	Under excavation Tank Ghawanimah	Road surface and side drain
27	15.18272	43.68324	Roofed Tank with corrugated zinc panels	Road surface and steps
28	15.18276	43.68341	Open Tank	
29	15.17795	43.68138	Open Tank Bait Abad	
30	15.172704	43.666043	Open Tank	
31	15.170859	43.665007	Open Tank Dhola'a	Culvert outlet and two humps station
32	15.1719	43.66562	Open Tank	Road Slope & channel
33	15.17223	43.66501	Open Tank	Road Slope & channel

**Annex 4 Sub road rianwater harvesting structures**

No	North	East	Description	Water Harvesting Technique
1	15.189273	43.685608	Roofed Tank	
2	15.189107	43.68617	Open Tank	
3	15.189272	43.68654	Open Tank	
4	15.189474	43.686656	Open Tank	
5	15.186315	43.689149	Roofed Tank	
6	15.186135	43.689184	Roofed Tank	
7	15.181842	43.693596	Roofed Tank	
8	15.181333	43.693821	Roofed Tank	
9	15.181248	43.694645	Roofed Tank	
10	15.180163	43.695045	Open Tank	
11	15.179287	43.696231	Open Tank	
12	15.178577	43.697312	Open Tank	
13	15.17767	43.70245	Roofed Tank	Road surface
14	15.17755	43.70227	Roofed Tank with old corrugated zinc panels and new panels	Road surface using two Stone Paved rolling dips & external catchment
15	15.17768	43.70174	Roofed Tank with Single Skin panels	Road surface using one rolling dips & side retaining wall spillway
16	15.17724	43.70161	Roofed Tank with Single Skin panels	Road surface using one Stone Paved rolling dips & channel
17	15.17722	43.70102	Old Cistern with Stone Arch Roof	
18	15.17733	43.70101	Old Cistern with Collapsed Stone Arch Roof	
19	15.17623	43.7011	Old Cistern with Stone Arch Roof	
20	15.17373	43.70248	Under Construction Tank	Road surface & external catchment
21	15.16629	43.7049	Roofed Tank with old corrugated zinc panels	Road surface by inside dry stone channel & external catchment
22	15.16439	43.70306	Roofed Tank	Road surface by outside dry stone curb & external catchment
23	15.16192	43.70126	Cylinder Open Tank PWP	Road surface & external catchment by collection channels
24	15.16127	43.70112	Sand Filter	
25	15.16063	43.7013	Rectangular Open Tank	Road surface& external catchment
26	15.15847	43.70089	Cylinder Open Tank	Road surface

No	North	East	Description	Water Harvesting Technique
27	15.15804	43.70103	Roofed Tank with old corrugated zinc panels	Road surface by Stone Paved Rolling Dip
28	15.15708	43.70048	Roofed Cistern	Road surface by channel from the road and check dry stones
29	15.15582	43.69906	Roofed Cistern	Road surface
30	15.15409	43.70076	Roofed Cistern	Road surface in-slope
31	15.15371	43.70068	Roofed Cistern	Road surface in-slope
32	15.15337	43.70071	Roofed Tank	Road surface by intake channel
33	15.15326	43.70072	Roofed Tank	Road surface by intake channel
34	15.15275	43.70125	Under Construction Cistern	
35	15.15116	43.70178	Roofed Cistern	Road surface by rolling dip & channel
36	15.15216	43.70195	Roofed Cistern	Road surface with sediments basin and inlet ditch
37	15.1524	43.7022	Roofed Cistern	Road surface with sediments basin
38	15.15041	43.70213	Roofed Cistern	Road surface it fills with sediments
39	15.15053	43.70215	Roofed Tank with wood shrubs roofs	Road surface
40	15.15007	43.70228	Roofed Cistern	Road surface
41	15.14863	43.70291	Under Construction Tank	Road surface
42	15.14444	43.70514	Roofed Cistern	Road surface
43	15.14094	43.70633	Open Tank	Road surface
44	15.14008	43.70668	Roofed Cistern	Road surface
45	15.13884	43.70712	Open Tank	
46	15.13816	43.70757	Under Construction Tank	Road surface
47	15.13768	43.70825	Open Cistern	
48	15.13639	43.71023	Roofed Cistern	
49	15.13639	43.7103	Roofed Cistern	
50	15.13616	43.71057	Roofed Cistern	
51	15.13614	43.71059	Roofed Cistern	
52	15.13583	43.71283	Roofed Tank	
53	15.13553	43.71334	Roofed Cistern	
54	15.13357	43.713	Roofed Tank	
55	15.12905	43.71468	Roofed Cistern	
56	15.12828	43.71452	Roofed Tank	Road surface
57	15.12818	43.71463	Open Tank	Road surface by an earth dug channel

## Annex 5 Stakeholders questionnaire analysis

### Water Resource

Water Resource	Percent of Responses	Percent of Cases	No of Responses
Rain	53.70%	100.00%	22
Water Network	4.90%	9.10%	2
Well	24.40%	45.50%	10
Water Truck	7.30%	13.60%	3
Spring	7.30%	13.60%	3
FogHarvesting	2.40%	4.50%	1
<b>Total</b>	<b>100.00%</b>	<b>186.40%</b>	<b>41</b>

### Water Scarcity Issues and Adaptation

Climate change risks and rain season change

. Roads & Water Harvesting

a. Data analysis of land ownership nearby road and running floods water use

b. Data analysis of road rainwater harvesting techniques:

RRWH Techniques	Percent of Responses	Percent of Cases	No of Responses
Side Ditches	9.10%	13.60%	3
Humps	57.60%	86.40%	19
Spillway	3.00%	4.50%	1
Channels	15.20%	22.70%	5
Culverts	3.00%	4.50%	1
Terraces	3.00%	4.50%	1
WH Structures	3.00%	4.50%	1
None	6.10%	9.10%	2
<b>Total</b>	<b>100.00%</b>	<b>150.00%</b>	<b>33</b>

### Data analysis of water rights

#### Usage & Benefits of RRWH

a. Data analysis of roads rainwater harvesting usage:

Usage of RRWH	Percent of Responses	Percent of Cases	No. of Responses
Drinking	14.80%	40.90%	9
Agriculture	31.10%	86.40%	19
Domestic & Livestock	26.20%	72.70%	16
Supplementary Irrigation	23.00%	63.60%	14
Not Used	4.90%	13.60%	3
<b>Total</b>	<b>100.00%</b>	<b>277.30%</b>	<b>61</b>

b. Data analysis for benefits from harvested rainwater from road:

Benefits of RRWH	Percent of Responses	Percent of Cases	No of Responses
Water Saving	43.80%	100.00%	21
Increase Production	35.40%	81.00%	17
Reduce Buying Water	8.30%	19.00%	4
Supplementary Irrigation	6.20%	14.30%	3
Others	6.20%	14.30%	3
<b>Total</b>	<b>100.00%</b>	<b>228.60%</b>	<b>48</b>

*The effect of road to water way patterns*

*Main problems prevent flood water delivery to farms and solution :*

*Roads water damages & mitigation*

*RRW Contamination, source, solution and purify techniques*

*Solution of contamination:*

*Purify techniques*

*. Women Rule in Water Resource and Rainwater Harvesting*

### ***Annex 6 Road engineers questionnaire analysis***

Road Engineers awareness on water harvesting from roads

appendix 1. Current culvert design understanding

C1 : How do you choose the location of culverts in road projects?

Multiple Response

#### Case Summary

	Cases					
	Valid		Missing		Total	
	N	Percent	N	Percent	N	Percent
\$C1 <sup>a</sup>	45	100.0%	0	.0%	45	100.0%

a. Dichotomy group tabulated at value 1.

#### \$C1 Frequencies Multiple Response

		Responses		Percent of Cases
		N	Percent	
Choose Location of Culverts <sup>a</sup>	Water ways and streams cross the road	35	36.5%	77.8%
	Detailed hydrologic study	31	32.3%	68.9%
	At every vertical sag curve	14	14.6%	31.1%
	At equal intervals	3	3.1%	6.7%
	Others	13	13.5%	28.9%
Total		96	100.0%	213.3%

a. Dichotomy group tabulated at value 1.

## C2 How Do you define the type of culverts in road projects?

Multiple Response

Case Summary

	Cases					
	Valid		Missing		Total	
	N	Percent	N	Percent	N	Percent
\$C2 <sup>a</sup>	45	100%	0	0%	45	100.0%

a. Dichotomy group tabulated at value 1.

## \$C2 Frequencies

		Responses		Percent of Cases
		N	Percent	
Define the type of culverts <sup>a</sup>	Technical Standards	16	17.8%	35.6%
	Detailed Hydrologic Study	22	24.4%	48.9%
	Typical Designs from MPWH and Consultant Experience	27	30.0%	60.0%
	Cost Analysis Alternative	11	12.2%	24.4%
	Others	14	15.6%	31.1%
Total		90	100.0%	200.0%

Dichotomy group tabulated at value 1.

## C3: How do you define the size of culverts in road projects?

Multiple Response

User-defined missing values are treated as missing

Statistics for each table are based on all the cases with valid data in the specified range(s) for all variables in each table.

Case Summary

	Cases					
	Valid		Missing		Total	
	N	Percent	N	Percent	N	Percent
\$C3 <sup>a</sup>	45	100.0%	0	0%	45	100.0%

a. Dichotomy group tabulated at value 1.

## \$C3 Frequencies

		Responses		Percent of Cases
		N	Percent	
Define the Size of Culverts <sup>a</sup>	Detailed Hydrologic Study	25	38.5%	55.6%
	Stream Line Noticed Width and Height	27	41.5%	60.0%
	Others	13	20.0%	28.9%
Total		65	100.0%	144.4%

a. Dichotomy group tabulated at value 1.

## C4: How do you design the Inlets of the culvert

Multiple Response

Case Summary

	Cases					
	Valid		Missing		Total	
	N	Percent	N	Percent	N	Percent
\$C4 <sup>a</sup>	43	95.6%	2	4.4%	45	100.0%

## Case Summary

	Cases					
	Valid		Missing		Total	
	N	Percent	N	Percent	N	Percent
\$C4 <sup>a</sup>	43	95.6%	2	4.4%	45	100.0%

a. Dichotomy group tabulated at value 1.

## \$C4 Frequencies

		Responses		Percent of Cases
		N	Percent	
Design of the culverts Inlets <sup>a</sup>	Detailed Hydrologic Study	13	18.6%	30.2%
	Typical Drawings and Inlet Type	32	45.7%	74.4%
	In Site Structural Designs As Needed	23	32.9%	53.5%
	Others	2	2.9%	4.7%
Total		70	100.0%	162.8%

Dichotomy group tabulated at value 1.

.C5: Does the scour depth been calculated?And does the transmitted sedimentation considered in sediment basin design before the Inlet and water velocity and the effect of it to the surrounding land at the outlet?

## Frequencies

## Scour Depth and Transmitted Sedimentation Calculation

		Frequency	Percent	Valid Percent	Cumulative Percent
Valid	No	12	26.7	26.7	26.7
	Yes	24	53.3	53.3	80.0
	None	9	20.0	20.0	100.0
	Total	45	100.0	100.0	

C6: How do you design the Outlets of the culvert

Multiple Response

## Case Summary

	Cases					
	Valid		Missing		Total	
	N	Percent	N	Percent	N	Percent
\$C6 <sup>a</sup>	44	97.8%	1	2.2%	45	100.0%

a. Dichotomy group tabulated at value 1.

## \$C6 Frequencies

		Responses		Percent of Cases
		N	Percent	
Design the Culvert Outlets <sup>a</sup>	Detailed Hydrologic Study	10	16.1%	22.7%
	Typical Drawings and Outlet Type	29	46.8%	65.9%
	In Site Structural Designs As Needed	22	35.5%	50.0%
	Others	1	1.6%	2.3%
Total		62	100.0%	140.9%



## Case Summary

	Cases					
	Valid		Missing		Total	
	N	Percent	N	Percent	N	Percent
\$C6 <sup>a</sup>	44	97.8%	1	2.2%	45	100.0%

Dichotomy group tabulated at value 1.

D1: How do you define the dimension and shape of side Ditches in road projects

## Case Summary

	Cases					
	Valid		Missing		Total	
	N	Percent	N	Percent	N	Percent
\$D1 <sup>a</sup>	44	97.8%	1	2.2%	45	100.0%

a. Dichotomy group tabulated at value 1.

## \$D1 Frequencies

		Responses		Percent of Cases
		N	Percent	
Define Side Ditch Dimension and Shape <sup>a</sup>	Typical Designs from MPWH and Consultant Experience	29	42.6%	65.9%
	Detailed Hydrologic Study	14	20.6%	31.8%
	Offset Distance from Asphalt Edge	11	16.2%	25.0%
	Others	14	20.6%	31.8%
Total		68	100.0%	154.5%

Dichotomy group tabulated at value 1.

**Annex 7 Road Profile**



جامعة صنعاء  
مركز المياه والبيئة

## تقييم إمكانيات حصاد مياه الأمطار من الطرق في اليمن

حالة دراسية : طريق مغربة مناخة - باب باحل  
بمحافظة صنعاء

رسالة ماجستير مقدمة إلى مركز المياه والبيئة - جامعة صنعاء كاستيفاء  
جزئي للحصول على درجة الماجستير في الإدارة المتكاملة للموارد المائية

مقدمة من

م / محمد عبد الله أحمد الأبيض  
بكالوريوس هندسة مدنية

تحت إشراف

المشرف المشارك

المشرف الرئيسي

د / عبدالله احمد المسوري  
أستاذ مساعد الطرق

د / شرف الدين عبدالله احمد صالح  
أستاذ مشارك المصادر المائية والري

مركز المياه والبيئة  
2018

# ملخص البحث

## تقييم إمكانيات حصاد مياه الأمطار من الطرق في اليمن

يعاني المزارعون والأشخاص الذين يعيشون في منطقة مناخية من ندرة المياه وشحة الموارد المائية . إن الهدف من هذا البحث هو الاستفادة المثلى من حصاد المياه من الطرق للمجتمعات المحلية في التنمية الاجتماعية والاقتصادية (حجم تخزين المياه وإعادة الاستخدام المفيد لها). بالإضافة إلى حماية البيئة على جانبي الطرق ، وذلك بالتركيز على طريق مغربة مناخية – باب باحل (عبارة عن طريق غير إسفلتي تحت الإنشاء بطول حوالي ٣٦ كم مرتبط من بدايته ونهايته بطريق صنعاء – الحديدة يبدأ من سوق مغربة مناخية وينتهي في باب باحل بطول ) والطريق الفرعي الريفى الرابط جبل عكباري - جبل العوي (عبارة عن طريق ريفى فرعى مرصوف بالأحجار في المقاطع الصعبة بإجمالي طول حوالي ١٦ كم وهو مرتبط بالطريق الرئيسي من بدايته ونهايته حيث يبدأ من الكيلومتر ٥ وينتهي عند الكيلومتر ٢٠,٥ من الطريق الرئيسي ) محافظة صنعاء. كما ناقش البحث دور التصميم الهندسي للطرق لتعزيز حصاد المياه من الطرق.

ركزت منهجية البحث على عمل مسح استطلاعي من خلال المشي الميداني لتسجيل وتوثيق مبادرات المزارعين لحصاد المياه وتوثيق وحصر منشآت تصريف المياه. مع عمل مقابلات عشوائية لعينة من المزارعين مع عمل استبيان على طول مقاطع الطرق قيد الدراسة وذلك لتقييم وعي المزارعين ، وحقوق المياه ، و اختلاف فترات الأمطار وكمياتها نتيجة تغير المناخ ، والتلوث ، ودور المرأة وأنشطتها في حصاد مياه الأمطار. علاوة على ذلك ، تم تعبئة استبيان من قبل مهندسي الطرق المتخصصين والذي يتضمن بيانات عن حصاد المياه من أسطح الطرق ومنشآت

تصريف المياه في الطرق. كما أجريت مراجعة للتصميم الهندسي للطرق لكل من الطريق الرئيسي والفرعي. وأخيرًا ، تم إجراء حساب لكمية مياه الأمطار المحتمل حصادها وتجميعها للطريق الرئيسي والطريق الفرعي ، وتم حساب الموازنة المائية لحصاد المياه لمنشآت حصاد المياه. ووجد البحث أن فوائد حصاد مياه الأمطار من الطرق للمزارعين تتمثل في ازدياد وفره المياه لإعادة تغذية المياه الجوفية ، والري التكميلي وتغطية الاحتياجات في موسم الجفاف. المياه المحصودة تستخدم للشرب والاستخدامات المنزلية ولسقي المواشي وللزراعة وهو ما ينعكس إيجابيا على حفظ المياه الجوفية وعلى زيادة إنتاجية المحاصيل.

من وجهة نظر المزارعين فقد توصل البحث إلى إن إنشاء الطرق قد يسبب تركيز السيول التي تسبب انجراف وتكون الاخاديد في التربة الزراعية ونقل الترسبات والطيني وكذلك تغيير منسوب المزرعة. بالإضافة إلى ذلك ، تظهر النتائج التي تم الحصول عليها أن النساء يلعبن دورا رئيسيا في توفير المياه ، وحصاد المياه سيساعد على تقليل الجهد والوقت لجلب وإحضار المياه من موارد المياه القريبة.

ومن ناحية أخرى ، لم يكن معظم مهندسي الطرق على وعي ودارية بمفهوم حصاد المياه أو استخدام المياه للري سواء من أسطح الطرق أو من منشآت الطرق ، ما لم يتم طلبها من قبل المزارعين. بينما حوالي ثلثي المهندسين أشاروا إلى إمكانية استخدام الطرق لإعادة تغذية المياه الجوفية. سيكون حصاد مياه الأمطار من الطرق المحتمل مصدرًا متجددًا للمياه إذا تم تطبيق إدارة المياه ودعم مبادرات المزارعين وتحسينها. بشكل عام ، يتم تصميم وتنفيذ منشآت تصريف المياه في الطرق من خلال تدابير مختلفة مثل الخبرة والتكلفة وطبيعة التضاريس ونوع المشروع.

وخلص البحث إلى أن المساحة الساكنة للطريق الرئيسي تتأثر بالمساحة الساكنة الطبيعية للطريق ، والمساحة الساكنة للعبارات ، والخواص الهندسية لسطح الطريق (المسافات بين نقاط التصريف في المنحنى الرأسي ، والميل العرضي ، وطريقة التعلية الجانبية ، وعدد المنحنيات الأفقية التي تؤثر على عدد نقاط التصريف) . علاوة على ذلك ، فإن الكمية التقديرية المحتمل حصادها من الطريق الرئيسي بأكمله من خلال المساحات الساكنة الطبيعية هي 1,662,729.25 متر مكعب سنوياً. كما أن الكمية التقديرية المحتمل حصادها من طول ١٠ كم في موقع ٤٠ عبارة ٥٢٩,١٧٨,٣١ متر مكعب سنوياً ، وكمية المياه المحتمل حصادها في المواقع المناسبة للعبارات وعددها ٢٢ عبارة تساوي ١٨٨,٤٤٦,٨٧ متر مكعب سنوياً والتي تمثل ٣٦٪ من إجمالي كمية المياه المتوقع حصادها.

وأخيراً ، يوصي البحث بتشجيع وتطوير مبادرات المزارعين تقنياً ومؤسسياً ، وينبغي أيضاً دعمها من الجهات الحكومية وبرامج المانحين. وينبغي تنظيم ورش عمل للتوعية والتدريب لمهندسي الطرق و أخصائيي الهيدرولوجيا ومستجمعات مياه. وعلاوة على ذلك ، يجب تكيف التصميم الهندسي للطرق لتسهيل حصاد مياه الأمطار من الطرق. وينبغي تكيف رسومات و مخططات كنتورية لسطح الطريق المطلوب مع مواقع مياه الوديان ، ومواقع العبارات، وخريطة استخدام الأراضي ، ومواقع حصاد مياه الأمطار من الطرق المحتملة لخدمة مرافق ومنشآت حصاد مياه الأمطار من الطرق.

الكلمات المفتاحية: حصاد مياه الأمطار من الطرق ، العبارات ، مهندسي الطرق ، المزارعين